



POWERING INNOVATION THAT DRIVES HUMAN ADVANCEMENT

© 2025 ANSYS, Inc. or its affiliated companies
Unauthorized use, distribution, or duplication is prohibited.

Getting Started with Mechanical: Structural Solution – Power Resistor



ANSYS, Inc.
Southpointe
2600 Ansys Drive
Canonsburg, PA 15317
ansysinfo@ansys.com
<https://www.ansys.com>
(T) 724-746-3304
(F) 724-514-9494

Release 2025 R1
January 2025

ANSYS, Inc. and
ANSYS Europe,
Ltd. are UL
registered ISO
9001:2015 com-
panies.

Copyright and Trademark Information

© 1986-2025 ANSYS, Inc. Unauthorized use, distribution or duplication is prohibited.

ANSYS, Ansys Workbench, AUTODYN, CFX, FLUENT and any and all ANSYS, Inc. brand, product, service and feature names, logos and slogans are registered trademarks or trademarks of ANSYS, Inc. or its subsidiaries located in the United States or other countries. ICM CFD is a trademark used by ANSYS, Inc. under license. All other brand, product, service and feature names or trademarks are the property of their respective owners. FLEXIm and FLEXnet are trademarks of Flexera Software LLC.

Disclaimer Notice

THIS ANSYS SOFTWARE PRODUCT AND PROGRAM DOCUMENTATION INCLUDE TRADE SECRETS AND ARE CONFIDENTIAL AND PROPRIETARY PRODUCTS OF ANSYS, INC., ITS SUBSIDIARIES, OR LICENSORS. The software products and documentation are furnished by ANSYS, Inc., its subsidiaries, or affiliates under a software license agreement that contains provisions concerning non-disclosure, copying, length and nature of use, compliance with exporting laws, warranties, disclaimers, limitations of liability, and remedies, and other provisions. The software products and documentation may be used, disclosed, transferred, or copied only in accordance with the terms and conditions of that software license agreement.

ANSYS, Inc. and ANSYS Europe, Ltd. are UL registered ISO 9001: 2015 companies.

U.S. Government Rights

For U.S. Government users, except as specifically granted by the ANSYS, Inc. software license agreement, the use, duplication, or disclosure by the United States Government is subject to restrictions stated in the ANSYS, Inc. software license agreement and FAR 12.212 (for non-DOD licenses).

Third-Party Software

See the legal information in the product help files for the complete Legal Notice for Ansys proprietary software and third-party software. If you are unable to access the Legal Notice, please contact ANSYS, Inc.

Conventions Used in this Guide

Please take a moment to review how instructions and other useful information are presented in this documentation.

- Procedures are presented as numbered lists. A single bullet indicates that the procedure has only one step.
- Bold type is used for the following:
 - Keyboard entries that should be typed in their entirety exactly as shown. For example, “**copy file1**” means you must type the word **copy**, then type a space, and then type **file1**.
 - On-screen prompts and messages, names of options and text boxes, and menu commands. Menu commands are often separated by greater than signs (>). For example, “click **HFSS > Excitations > Assign > Wave Port.**”
 - Labeled keys on the computer keyboard. For example, “Press **Enter**” means to press the key labeled **Enter**.
- Italic type is used for the following:
 - Emphasis.
 - The titles of publications.
 - Keyboard entries when a name or a variable must be typed in place of the words in italics. For example, “**copy filename**” means you must type the word **copy**, then type a space, and then type the name of the file.
- The plus sign (+) is used between keyboard keys to indicate that you should press the keys at the same time. For example, “Press Shift+F1” means to press the **Shift** key and, while holding it down, press the **F1** key also. You should always depress the modifier key or keys first (for example, Shift, Ctrl, Alt, or Ctrl+Shift), continue to hold it/them down, and then press the last key in the instruction.

Accessing Commands: *Ribbons*, *menu bars*, and *shortcut menus* are three methods that can be used to see what commands are available in the application.

- The *Ribbon* occupies the rectangular area at the top of the application window and contains multiple tabs. Each tab has relevant commands that are organized, grouped, and labeled. An example of a typical user interaction is as follows:

"Click **Draw > Line**"



This instruction means that you should click the **Line** command on the **Draw** ribbon tab. An image of the command icon, or a partial view of the ribbon, is often included with the instruction.

- The *menu bar* (located above the ribbon) is a group of the main commands of an application arranged by category such File, Edit, View, Project, etc. An example of a typical user interaction is as follows:

"On the **File** menu, click the **Open Examples** command" means you can click the **File** menu and then click **Open Examples** to launch the dialog box.

- Another alternative is to use the *shortcut menu* that appears when you click the right-mouse button. An example of a typical user interaction is as follows:

"Right-click and select **Assign Excitation > Wave Port**" means when you click the right-mouse button with an object face selected, you can execute the excitation commands from the shortcut menu (and the corresponding sub-menus).

Getting Help: Ansys Technical Support

For information about Ansys Technical Support, go to the Ansys corporate Support website, <http://www.ansys.com/Support>. You can also contact your Ansys account manager in order to obtain this information.

All Ansys software files are ASCII text and can be sent conveniently by e-mail. When reporting difficulties, it is extremely helpful to include very specific information about what steps were taken or what stages the simulation reached, including software files as applicable. This allows more rapid and effective debugging.

Help Menu

To access help from the Help menu, click **Help** and select from the menu:

- **[product name] Help** - opens the contents of the help. This help includes the help for the product and its *Getting Started Guides*.
- **[product name] Scripting Help** - opens the contents of the *Scripting Guide*.
- **[product name] Getting Started Guides** - opens a topic that contains links to Getting Started Guides in the help system.

Context-Sensitive Help

To access help from the user interface, press **F1**. The help specific to the active product (design type) opens.

You can press **F1** while the cursor is pointing at a menu command or while a particular dialog box or dialog box tab is open. In this case, the help page associated with the command or open dialog box is displayed automatically.

Table of Contents

Table of Contents	Contents-1
1 - Introduction	1-1
2 - Set Up the Project	2-1
Launch Ansys Electronics Desktop	2-1
Insert Icepak and Mechanical Designs	2-2
Set 3D UI Options	2-4
3 - Construct the Geometry	3-1
Draw a Lead Wire	3-1
Draw an End Cap	3-6
Draw the Resistor Body	3-7
Draw a Solder Joint	3-9
Perform Object Subtractions	3-11
Mirror Objects to Complete the Geometry	3-15
Copy Geometry to Icepak Design	3-16
Adjust Air Region Size	3-18
Add Void in Air Region	3-20
4 - Set Up and Solve Icepak Design	4-1
Assign Flow Openings	4-1
Assign Thermal Sources	4-5
Add Solution Setup and Solve	4-8
Create Temperature Overlay	4-11
5 - Set Up and Solve Mechanical Design	5-1
Assign Fixed Supports	5-1
Assign Thermal Condition	5-3
Add Solution Setup and Solve	5-5
6 - Evaluate Structural Results	6-1
Create Temperature Overlay	6-1
Create and Animate Displacement Overlay	6-4

Create Equivalent Stress Overlay	6-8
Create Fields Summary	6-13

1 - Introduction

In this *Getting Started* guide, you will learn how to use the *Ansys Electronics Desktop* application to determine the displacement and stresses caused by thermal expansion of a power resistor. You will create an Icepak design to calculate the temperature distribution within the resistor. The Mechanical–Structural design will import the temperatures from Icepak.

Specifically, this guide provides an example of constructing a model, copying and pasting the geometry to a second design, setting up and solving an *Icepak* analysis, linking Icepak to the *Mechanical–Structural* design, setting up and solving the structural design, and reviewing the displacement and stress results.

By following the procedures in this guide, you will learn how to perform the following tasks:

- Insert an Icepak and a Mechanical design
- Set units and coordinate system axis size
- Set 3D UI options
- In Mechanical:
 - Choose the Structural solution type
 - Draw a wire lead
 - Draw an end cap
 - Draw the resistor body
 - Draw a solder joint
 - Perform object subtractions
 - Mirror objects to complete the geometry
- Copy geometry from Mechanical to Icepak
- In Icepak:
 - Modify air region size
 - Add void in air region
 - Assign flow openings
 - Assign thermal sources
 - Setup, validate, and solve steady-state analysis
 - Create temperature overlay
- In Mechanical:
 - Assign thermal condition excitation
 - Assign fixed support boundaries
 - Set up, validate, and solve structural analysis
 - Overlay imported temperatures and compare to Icepak
 - Create and animate displacement magnitude overlay

- Create equivalent stress overlay
- Create a fields summary (stress, strain, and reaction forces)

The resistor body material is Al₂O₃ ceramic (aluminum oxide), the end caps are nickel, the wire leads are copper, and there are two solder joints of 60-40 tin-lead alloy. The resistor operates at a heat dissipation of 7.5 watts. The outlet air velocity in Icepak is 0.5 meters per second. The flat circular face of each solder object has a negative heat source of 0.5 watts to represent heat conducted into the copper traces of a circuit board (not included in the model). The remaining 6.5 watts of heat is removed by convection. The drawing length unit is millimeters.

Temperature results from Icepak are coupled to the Mechanical–Structural solution. The flat circular faces of each solder object are fixed in the structural model. Stresses are produced by the varying temperatures, differing coefficients of thermal expansion of the materials, and the resulting thermal strain. Additionally, the fixed supports anchor the bottom of the leads and result in slight bending of the wires as the resistor body elongates. However, this last effect is negligible because the wires are thin and provide little resistance to slight bending.



Note:

The remaining images in this guide were captured using the following settings:

- *Grid*: **Shown** for construction steps; **Hidden** for all other images
- *Ruler*: **Shown** for construction steps; **Hidden** for all other images
- *Coordinate System*: **Hidden** for results images, **Small** for all other images

Use the same settings if you want your screen to exactly match the subsequent images in this guide (optional steps are included in the procedures).

2 - Set Up the Project

In this chapter, you will perform the following tasks:

- Launch the Ansys Electronics Desktop application
- Insert an Icepak design
- Insert a Mechanical design
- Set units and coordinate system axis size
- Choose the Mechanical solution type (Structural)
- Save the project to a working folder

Launch Ansys Electronics Desktop

For convenience, a shortcut to the Ansys Electronics Desktop (EDT) application is placed on your desktop during program installation. Optionally, you may want to pin the shortcut to your Windows Start Menu too. Before proceeding to the next topic, launch EDT and add a blank project, as follows:

1. Double-click the  **Ansys Electronics Desktop** shortcut on your desktop (or the same shortcut on your Start Menu).

The Ansys Electronics Desktop application opens:

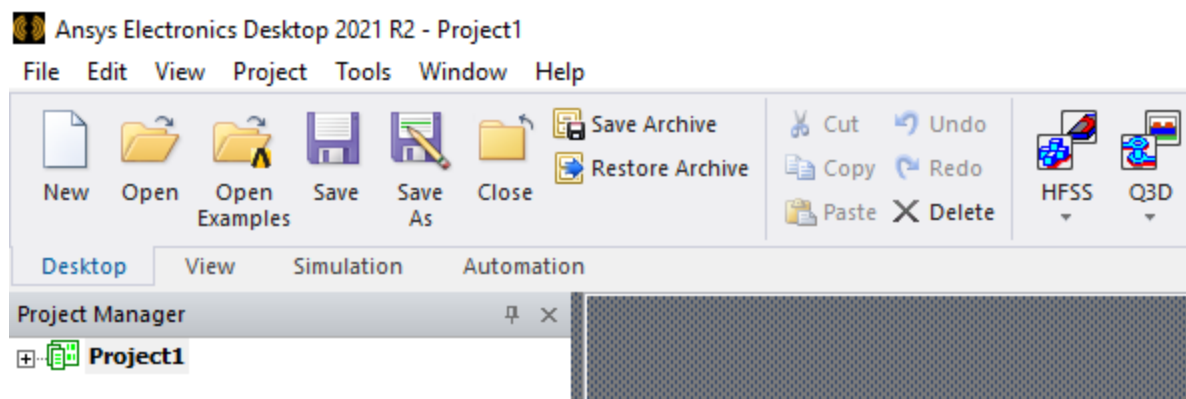

Note:

When you launch the application, a new, blank project is created automatically. However, if you were previously using the application and closed the project, you will have to create a new project by completing the following optional step.

2. If no project is listed in the Project Manager, click  **New** on the **Desktop** ribbon tab. **Projectx** appears at the top of the Project Manager.

Insert Icepak and Mechanical Designs

Insert an Icepak design and choose the units and coordinate axis size as follows:

1. On the **Desktop** ribbon tab, click  **Icepak**.
The Icepak design is listed beneath *Projectx* in the Project Manager.
2. On the **Draw** ribbon tab, click **Units**. Then:
 - a. In the *Set Model Units* dialog box, ensure that **mm** is the chosen in the **Select units** drop-down menu.
 - b. Click **OK**.
3. Optionally, from the menu bar, click **View > Coordinate System > Small** to make your coordinate system display consistent with the screenshots in this guide.
4. From the menu bar, click **Icepak > Solution Type**. Then:
 - a. Ensure that the selected *Solution types* option is **Steady State** and the *Problem types* option is **Temperature and Flow**, as shown in the following dialog box image:

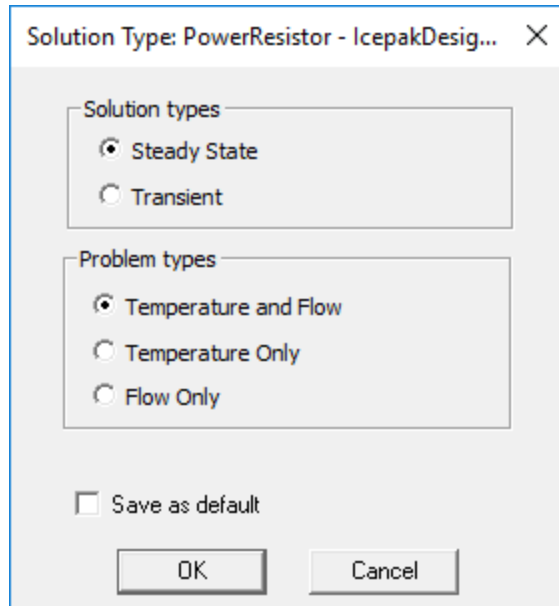

- b. Click **OK**.

Insert a Mechanical design and choose the solution type, units, and coordinate axis size as follows:

5. On the **Desktop** ribbon tab, click  **Mechanical**.

The mechanical design is listed beneath *Projectx* in the Project Manager:

Note:

The default solution type for mechanical designs is *Thermal*. However, you can change the default choice to the type you use most frequently. In the next step, you will determine the current *Solution Type* and change it if necessary.

6. If the design is not listed as **MechanicalDesignx (Structural)** in the Project Manager, use the menu bar and click **Mechanical > Solution Type**. Then:

- a. Select **Structural** from the *Solution Type* dialog box that appears.

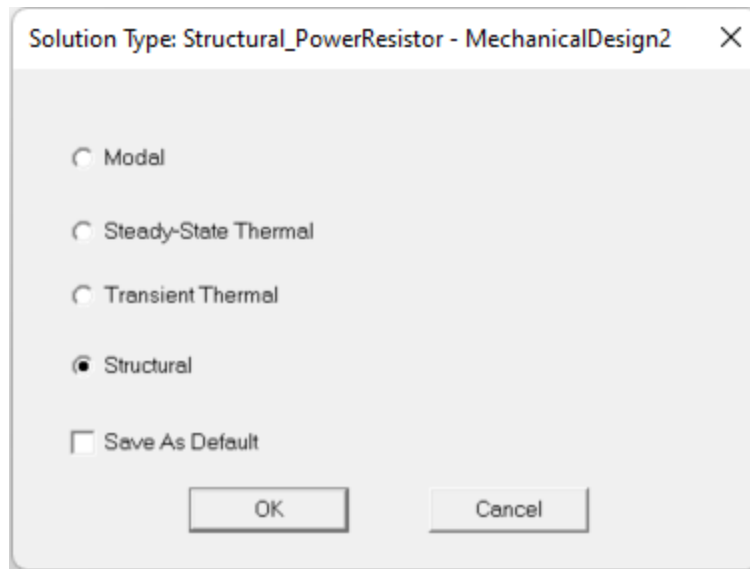

- b. Click **OK**.
7. Optionally, from the menu bar, click **View > Coordinate System > Small** to make your coordinate system display consistent with the screenshots in this guide.

Each separate design retains its own units, coordinate system option, and other customizations.

Finally, save the project to a suitable working folder and specify the file name, as follows:

8. On the **Desktop** ribbon tab, click  **Save As**.
9. Navigate to a working folder of your choice.

Note:

Optionally, you can click the **Create New Folder** icon () within the *Save As* dialog box to create a new working folder in a suitable location.

10. In the **File name** text box, type **Structural_PowerResistor** and click **Save**.

Set 3D UI Options

Ensure that the legacy view orientation scheme is *not* being used, since the instructions and images in this guide are based on the new orientation scheme introduced in release 2024 R1.

Although this option can only be accessed once a design is added to a project, it is a global option. Your choice is retained for all future program sessions, projects, and design types that use the 3D Modeler or that produce 3D plots of results. Therefore, enabling or clearing the legacy view orientations in either design in this exercise sets the behavior for both designs.

1. From the menu bar, click **View > Options**.

The *3D UI Options* dialog box appears.

2. Ensure that **Enable Legacy View Orientation** is cleared:

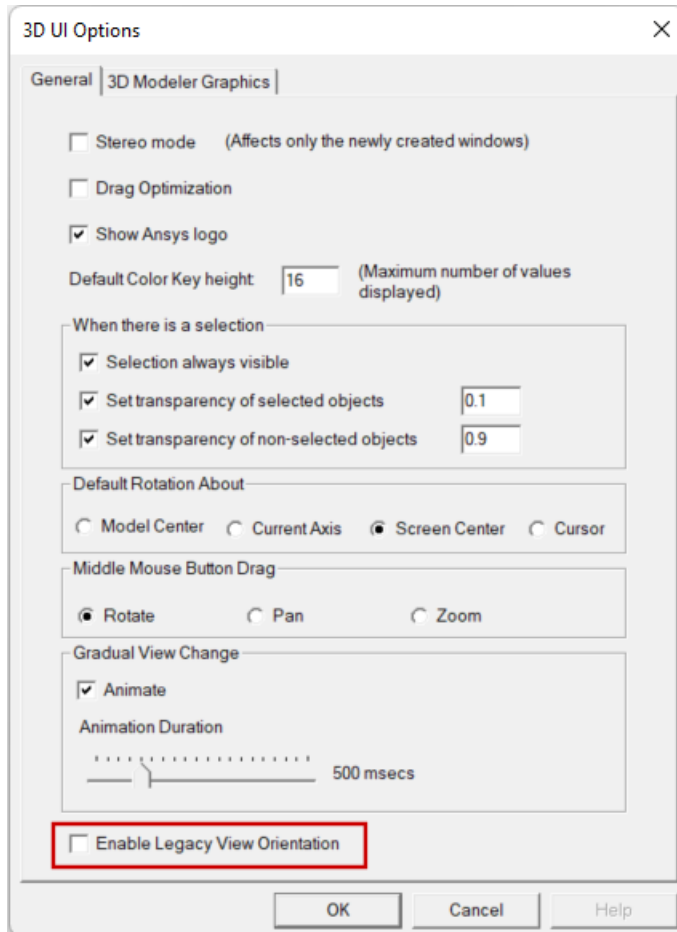

3. Click **OK**.

3 - Construct the Geometry

You will build the geometry in the Mechanical–Structural design and then copy and paste it to the Icepak design.

In the Project Manager, **MechanicalDesign1 (Structural)** should be listed in bold text, indicating that it is the active design. The last design inserted into the project becomes the active design.

In the subtopics that follow, you will complete the following drawing tasks:

- Draw a wire lead
- Draw an end cap
- Draw resistor body
- Draw a solder joint
- Perform object subtractions
- Mirror objects to complete geometry
- Copy geometry from Mechanical design to Icepak design
- Adjust the air region X and Y padding
- Add a void within the air region

Before proceeding to the next topic, complete the following two steps in the Project Manager:

1. Collapse the **IcepakDesign1 (SteadyState)** branch to minimize the chance of performing an operation on the wrong design.
2. If you previously changed the active window, double-click **MechanicalDesign1 (Structural)** to make it active again and to bring the associated *Modeler* window to the foreground.

Draw a Lead Wire

You will draw a small circle on the global XY plane and a polyline on the global YZ plane. The polyline will consist of one curved and two straight segments. The circle will be swept along the polyline to create a solid lead wire. You will start at the -Y end of the model.

1. On the *Draw* ribbon tab, click  **Draw circle**. Then:
 - a. Press **F4** to use the *dialog box* coordinate entry mode.
 - b. In the **Command** tab of the *Create Circle* dialog box, enter the values shown in the following image:

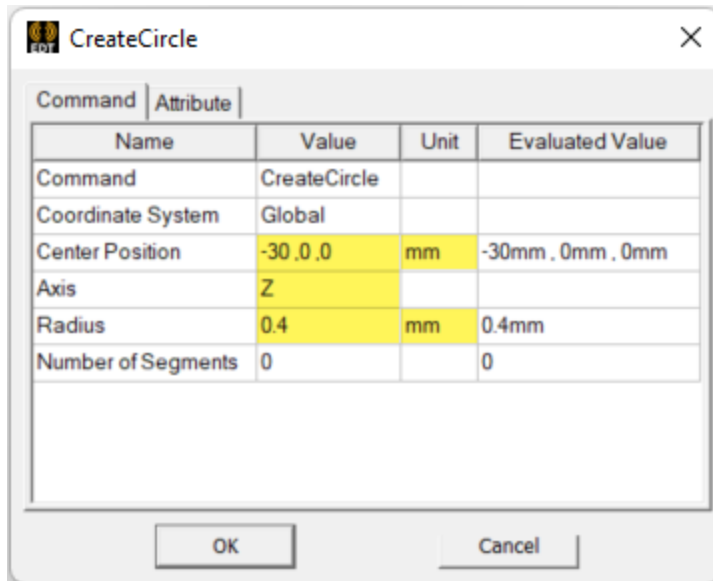

- c. Under the **Attribute** tab of the dialog box, change the object **Name** to **Wire**.
 - d. Click **OK**.
2. On the **Draw** ribbon tab, click **Orient** > **Trimetric**.

This view orientation will suit the geometry you are creating.

3. Use your mouse wheel or **Zoom Out** command to zoom out until both the small circle and the coordinate origin are visible in the Modeler window.

If you use *Fit All*, the circle will fill the screen. A further out viewpoint will work best for drawing the next object. You may also need to zoom or pan occasionally as the subsequent drawing steps are completed.

4. On the **Draw** ribbon tab, switch the **Drawing plane** from **XY** to **XZ**:

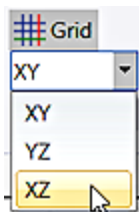

Note:

You will next draw a series of line segments. While you can specify coordinates at any point in 3D space, arcs that you draw will be generated parallel to the drawing plane. Since the polyline you will draw contains an arc segment in the XZ plane, you must make XZ the active drawing plane.

5. On the *Draw* ribbon tab, click  **Draw line**.

The *Draw line* command does not support the dialog box coordinate entry mode. So, you will use the coordinate text boxes in the status bar at the bottom of the screen to specify the coordinates, as follows:

- a. Specify the absolute X, Y, and Z coordinates of the first point as shown in the following image and press **Enter**:

**Tip:**

Use the **Tab** key to jump into the first coordinate entry text box and to navigate between these boxes. Be careful not to move the mouse while entering coordinates in this manner. If the mouse is moved, the cursor location will override the typed coordinates, and you'll have to enter them again.

However, if you move the mouse intentionally, after specifying the first point and pressing **Enter**, the coordinate input mode will automatically change from *Absolute* to *Relative*. Then, you can **Tab** into the **dX** coordinate entry text box. Otherwise, you can manually select the coordinate input mode from the drop-down menu near the right end of the status bar.

- b. Switch to the **Relative** mode, either by moving the mouse or using the drop-down menu in the Status Bar. Then, enter the following coordinates for the second point, and press **Enter**:





Notice that the X, Y, and Z labels change to **dX**, **dY**, and **dZ** for relative coordinates.

- c. Right-click in the Modeler window and choose **Set Edge Type > Center Point Arc** from the shortcut menu.
- d. Specify the following relative coordinates for the center of the arc segment and press **Enter**:



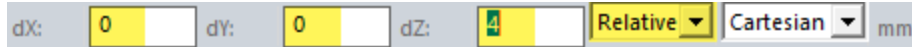

- e. Specify the following relative coordinates for the endpoint of the arc segment and press **Enter**:

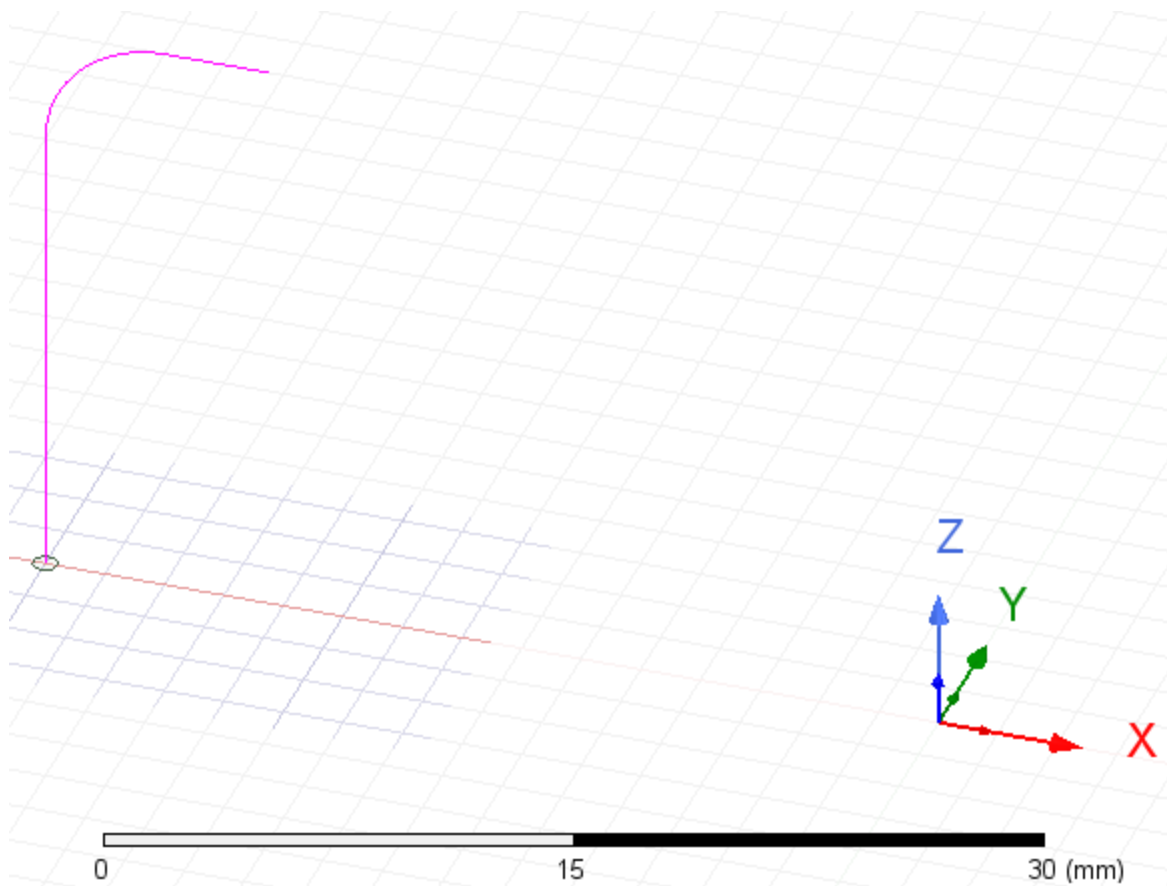

- f. Right-click in the Modeler window and choose **Set Edge Type > Straight**.
 - g. Specify the following relative coordinates for the final point and press **Enter**:
- 
- h. Right-click in the Modeler window and choose **Done**.
6. Click in the Modeler window background to clear the selection and zoom or pan as required for a good view of the model.
 7. On the **Draw** ribbon tab, return to the **XY Drawing Plane**.

The completed circle and polyline should look like the following image:



8. In **Object** selection mode, click the circle and then **Ctrl+click** the polyline to select both objects.
9. On the **Draw** ribbon tab, click  **Sweep along path**.
 - In the *Sweep along path* dialog box, accept the default options and click **OK** to create the solid lead wire.

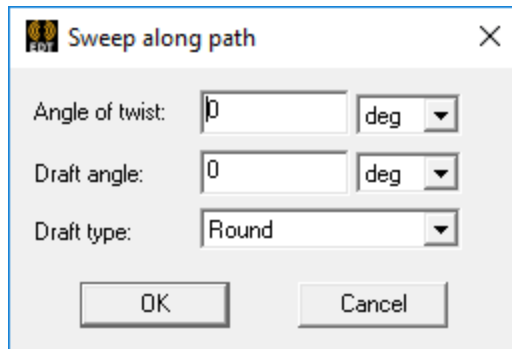

The completed lead wire should look like the following image. Do **not** clear the selection yet.

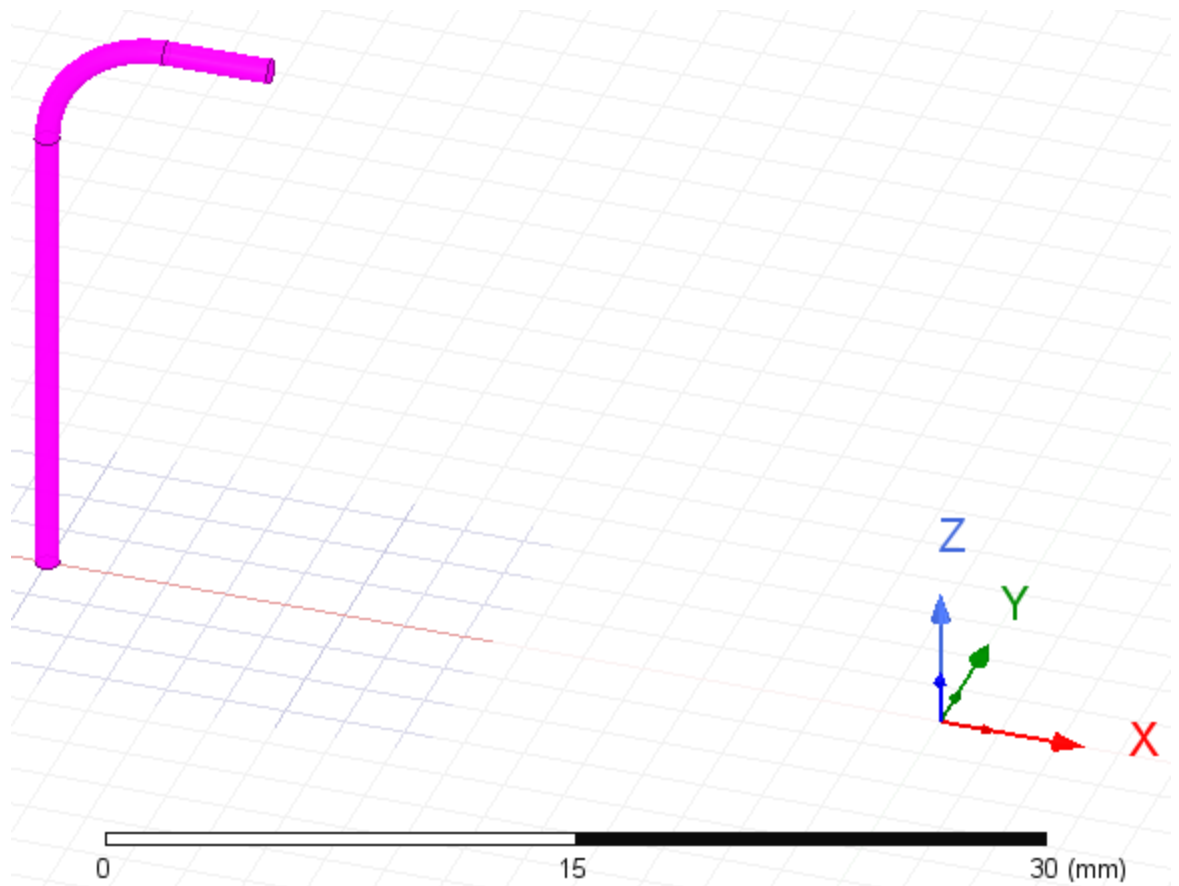

10. While the completed lead wire is still selected, make the following changes in the **Attribute** tab of the docked *Properties* window:
 - a. Choose **Edit** from the **Material** drop-down menu, select **copper** from the *Select Definition* dialog box, and click **OK**.
 - b. Select the **Material Appearance** option.
11. Clear the current selection.

The wire now has a copper color and is listed under *Model > Solids > copper* in the History Tree.

Draw an End Cap

You will draw a solid cylinder and define its properties. The end cap will not be complete until a later procedure, at which time you will subtract the resistor body from the end cap.

1. On the *Draw* ribbon tab, click  **Draw cylinder**.

The program should still be in the dialog box entry mode. Next:

- a. In the **Command** tab of the *CreateCylinder* dialog box, enter the values shown in the following image:

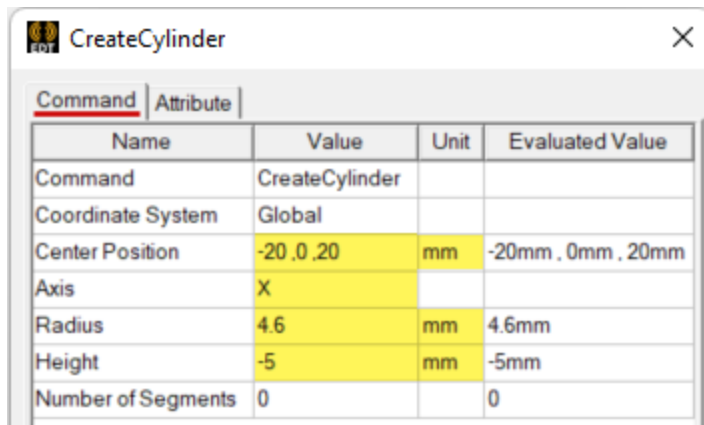

- b. Under the **Attribute** tab of the dialog box, change the object **Name** to **EndCap**.
 - c. Choose **Edit** from the **Material** drop-down menu, select **nickel, DC** from the *Select Definition* dialog box, and click **OK**.
 - d. Press **OK** to close the *CreateCylinder* dialog box.
2. While the end cap is still selected, select the **Material Appearance** option in the **Attribute** tab of the docked *Properties* window.
 3. Clear the selection and zoom or pan as required for a good view of the model, which

should look like the following image:

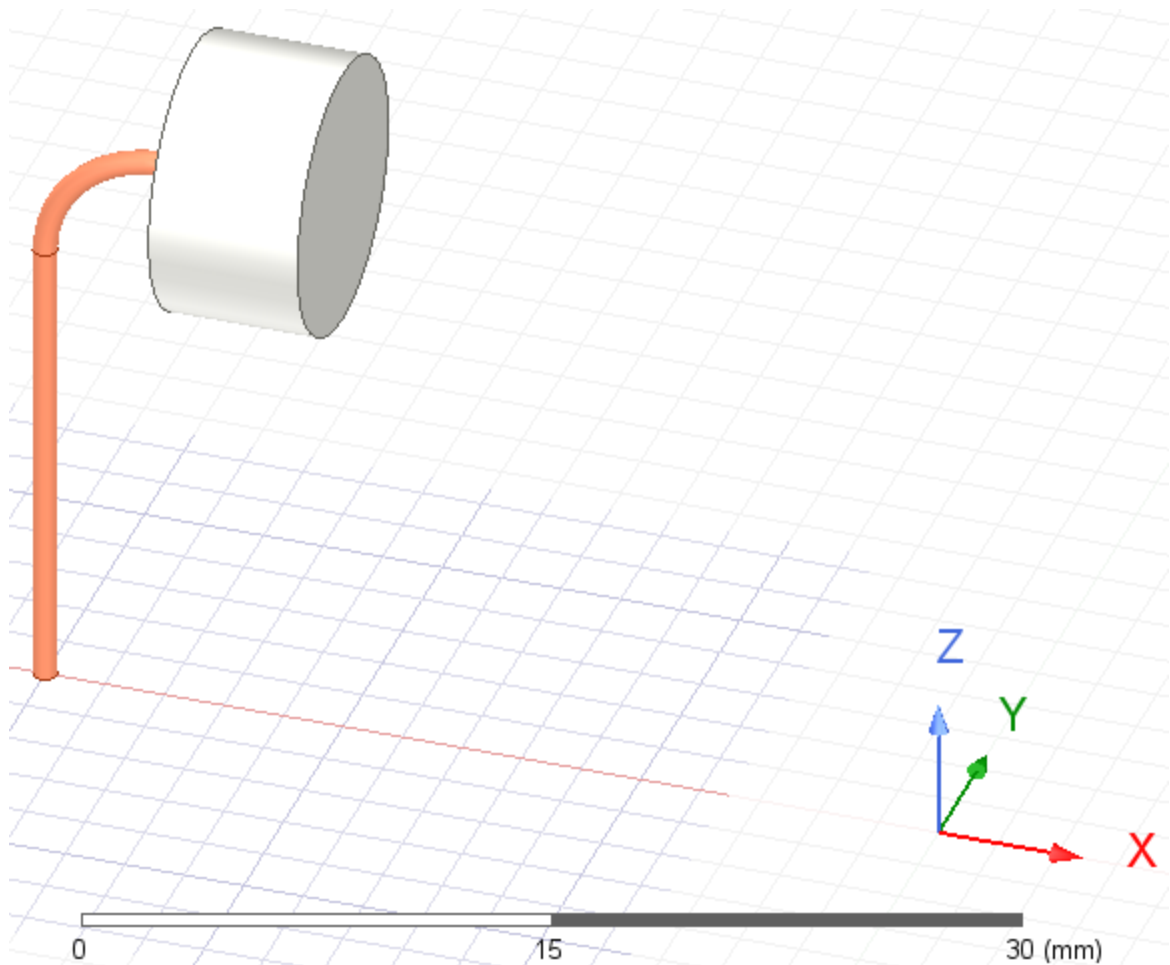

Draw the Resistor Body

You will draw a solid cylinder, name it *Body* and define its properties. You will also draw a second cylinder and name it *Core*. The resistor body will not be complete until a later procedure, at which time you will subtract the core from the body. Prior to subtracting the core, you will subtract the full body from the end cap.

1. On the *Draw* ribbon tab, click  **Draw cylinder**.

The program should still be in the dialog box entry mode. Next:

- a. In the **Command** tab of the *CreateCylinder* dialog box, enter the values shown in the following image:

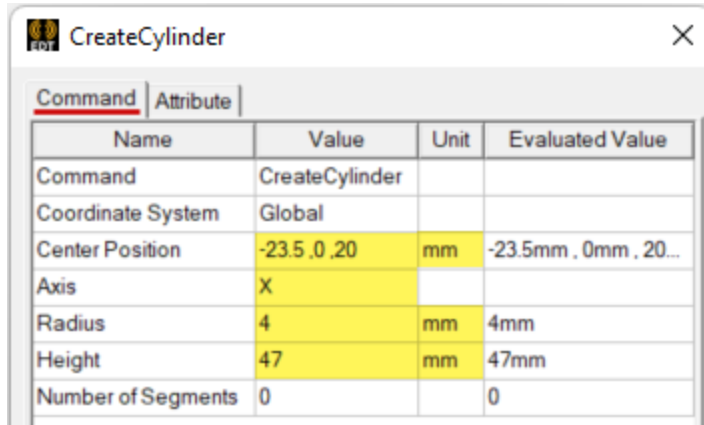

- b. Under the **Attribute** tab of the dialog box, change the object **Name** to **Body**.
 - c. Choose **Edit** from the **Material** drop-down menu, select **AI2_O3_ceramic** from the *Select Definition* dialog box, and click **OK**.
 - d. Clear the **Material Appearance** option if it is currently selected.
 - e. Click the **Color** box, specify the following custom color, and then click **OK** to close the *Color* dialog box:

Red: 180, Green: 170, Blue: 160
 - f. Click **OK**.
2. Click the  **Draw cylinder** command once more to draw a second cylinder. Then:
- a. In the **Command** tab of the *CreateCylinder* dialog box, enter the values shown in the following image:

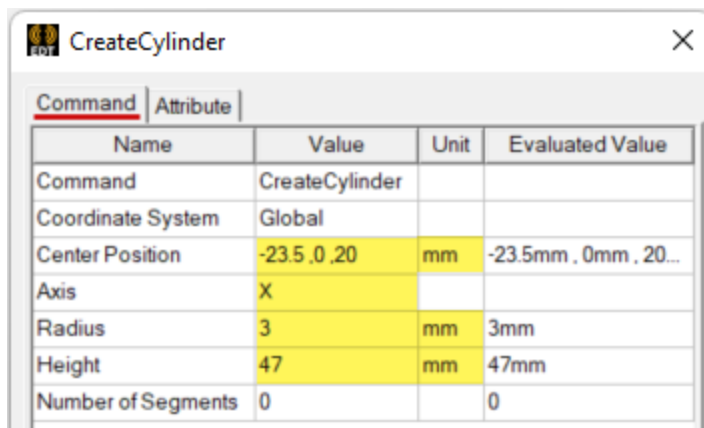

- b. In the **Attribute** tab of the *CreateCylinder* dialog box, change the **Name** to **Core**.

The material selection does not matter because this cylinder will only be used as a cutting tool to subtract from the resistor body in a later procedure. Keep the default

color.

- c. Click **OK**.
3. Clear the selection and zoom or pan as required for a good view of the model, which should look like the following image:

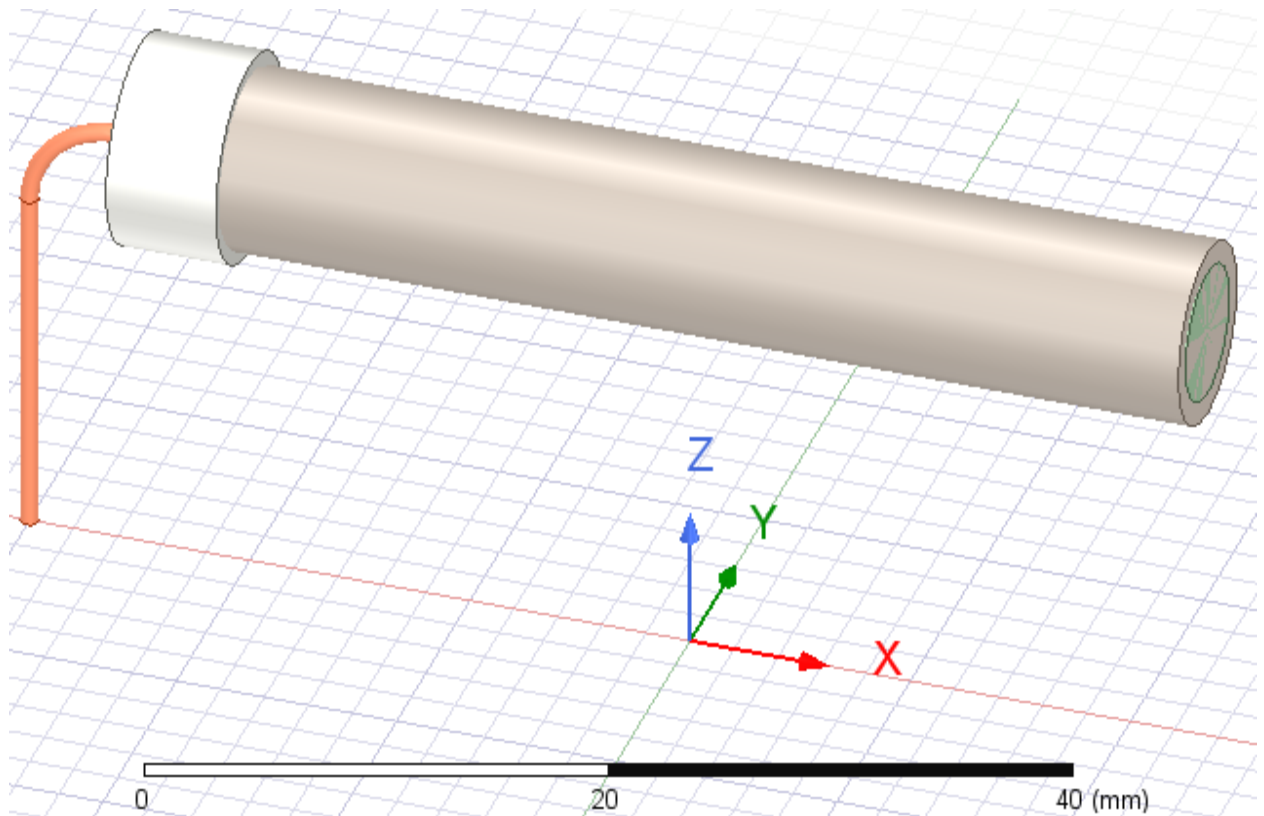

Draw a Solder Joint

You will draw a conic solder joint, name it *Solder* and define its properties. The solder joint will not be complete until a later procedure, at which time you will subtract the lead wire from it.

1. On the *Draw* ribbon tab, click  **Draw cone**.

The program should still be in the dialog box entry mode. Next:

- a. In the **Command** tab of the *CreateCone* dialog box, enter the values shown in the following image:

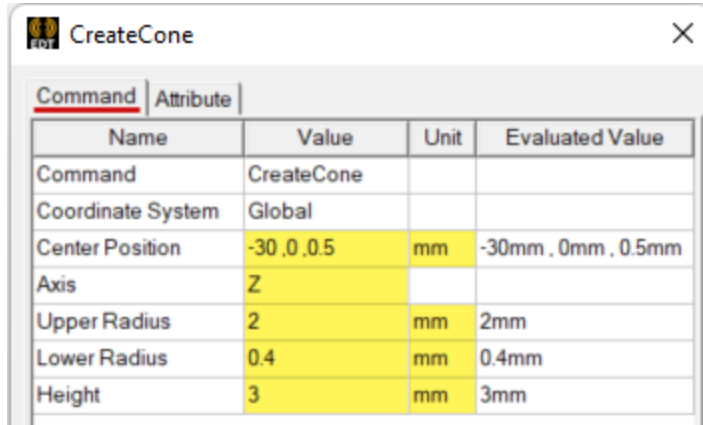

- b. Under the **Attribute** tab of the dialog box, change the object **Name** to **Solder**.
- c. Choose **Edit** from the **Material** drop-down menu. Then, in the *Select Definition* dialog box that appears, do the following:
 - i. Click the **ellipsis button (...)** near the upper-right corner of the dialog box.
 - ii. Ensure that at least the **Materials** and **GRANTA Materials Data for Simulation** libraries are selected:

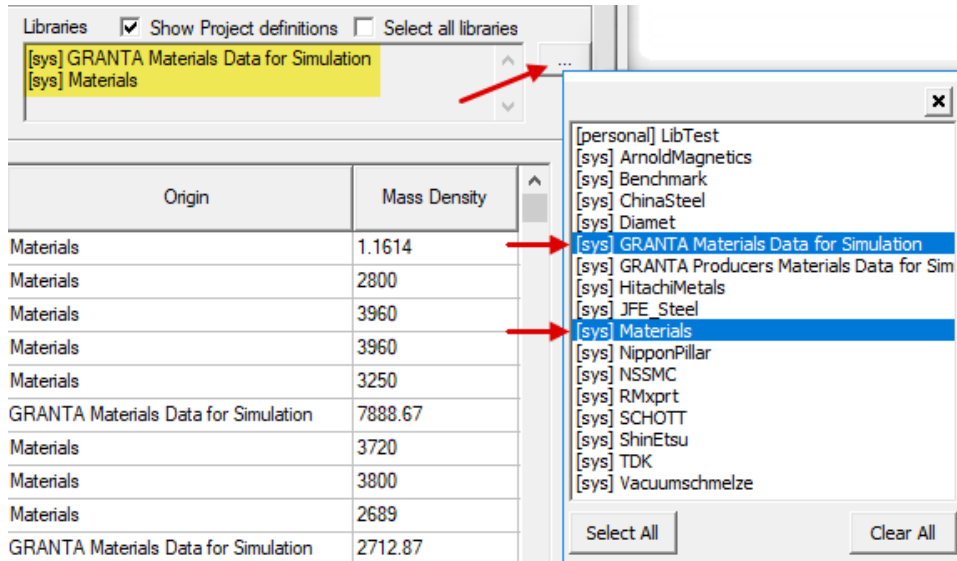

- iii. Click the **X** button in the top-right corner of the library list to close it.
- iv. Locate and select **Solder, tin-lead (60-40)**, which is from the *GRANTA* library.
- v. Click **OK** to close the *Select Definition* dialog box.
- d. Click **OK** to close the *CreateCone* dialog box.
2. While the solder joint is still selected, select the **Material Appearance** option in the **Attribute** tab of the docked *Properties* window.
3. Clear the selection.

The model should now look like the following image:

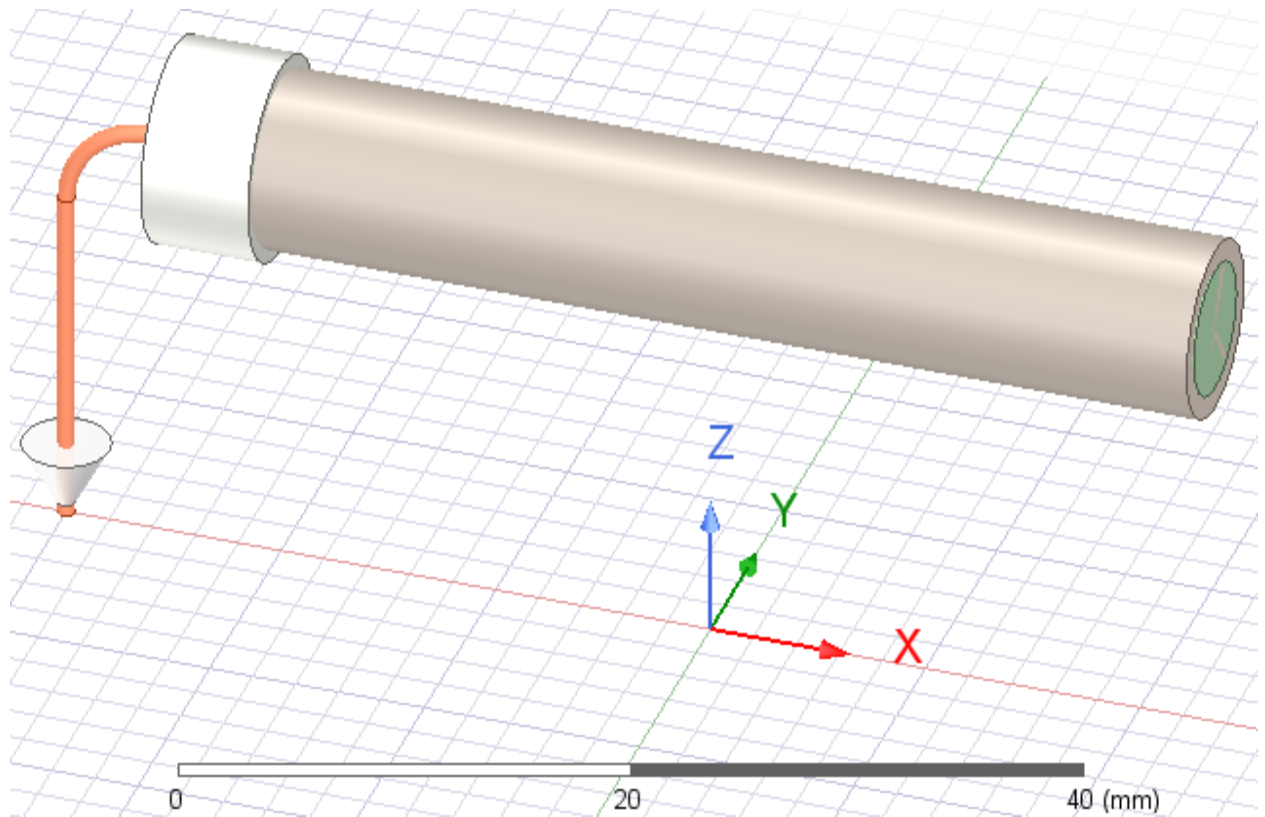

Perform Object Subtractions

You will next perform the following subtractions:

- Subtract wire leads from solder joints and end caps (cloning the tool object)
- Subtract resistor body from end caps (cloning the tool object)
- Subtract core cylinder from resistor body (discarding the tool object)

Note:

- The first subtraction operation eliminates any overlap of the wire leads with the end caps and solder.
Alternatively, implicit subtraction could automatically resolve geometry overlaps in the Mechanical–Structural solution, making the wire take precedence at the end cap and solder intersection regions.
- The second and third of these subtraction operations are being performed because the end caps and resistor body are hollow. The resistor body will be subtracted from the end caps, the core cylinder from the resistor body, and then the core cylinder discarded.

Alternatively, the core cylinder could be retained after the subtraction operation and defined as an air object. Since the conductivity of air is insignificant compared to the body and end caps, the air inside the resistor is being neglected.

Secondly, implicit subtraction and object priorities could be used if the core is retained as an air body.

Lastly, the core's *Solve Inside* attribute could be cleared in Icepak for it to be treated as a void. However, this attribute cannot be cleared for the Mechanical–Structural solution because that would prevent displacement of its surfaces, also preventing the shared resistor body and end cap faces from displacing. So the core, if retained, must be an air body in the structural solution.

Complete the object subtractions as follows:

1. In **Object** selection mode, select the **Solder**, **EndCap**, and **Wire** (in that specific order).
2. On the *Draw* ribbon tab, click  **Subtract**. Then:
 - a. In the *Subtract* dialog box, select **EndCap** in the *Tool Parts* list and click the **left-arrow** button to move this object to the *Blank Parts* list.
 - b. Select **Clone tool objects before operation**.
 - c. Ensure that the dialog box matches the following image and then click **OK** to com-

plete the first subtraction.

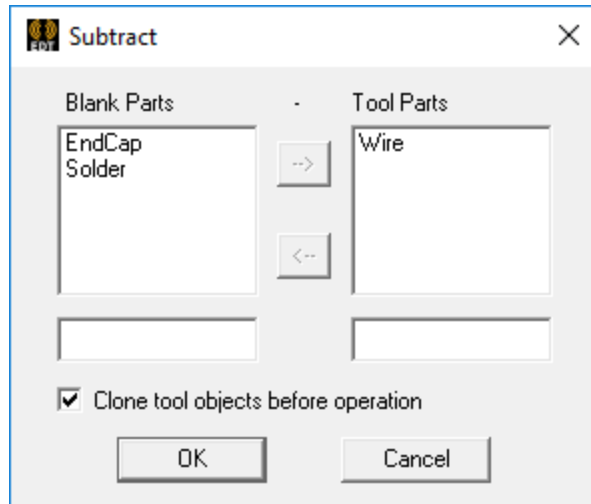

3. Select the **EndCap** and **Body** (in that specific order).
Be careful to select the outer *Body* object and not the *Core* object within it.
4. Again, click  **Subtract**. Then:
 - a. Select **Clone tool objects before operation**.
 - b. Ensure that the dialog box matches the following image and then click **OK** to complete the second subtraction.

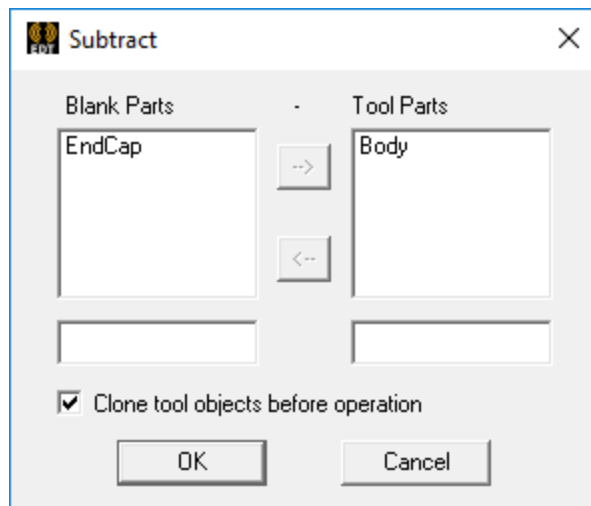

5. Select the **Body** and **Core** (in that specific order).
6. Again, click  **Subtract**. Then:
 - Ensure that the dialog box matches the following image and then click **OK** to complete the third and final subtraction. This time, do **not** select the clone tools option,

since we do not want to retain the cutting tool (Core object).

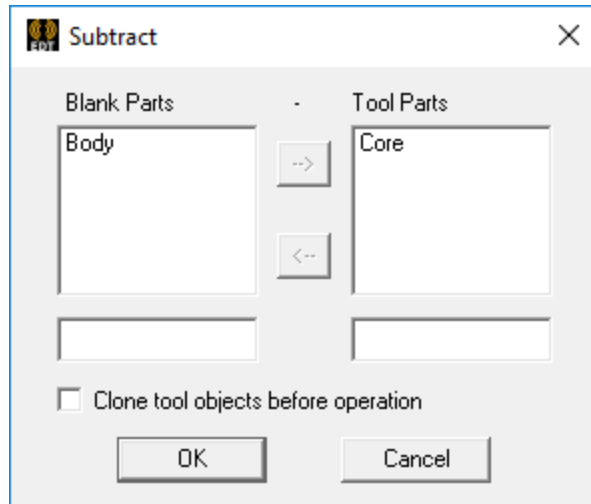

7. Clear the selection.

The model should now look like the following image:

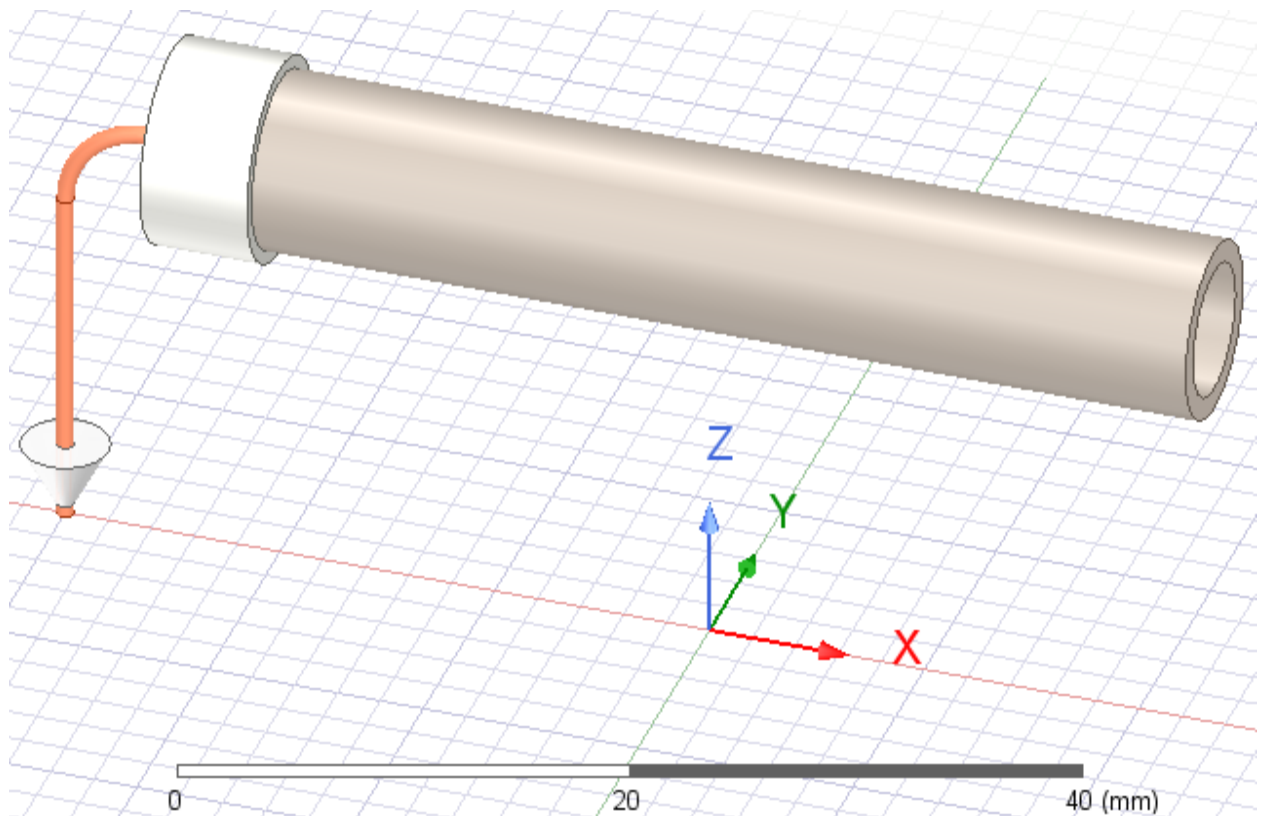

8. Optionally, temporarily hide the resistor body and wire lead to verify that holes have been cut through the solder and end cap, as expected. Then:
 - a. Zoom and rotate the model for a good view of the holes.

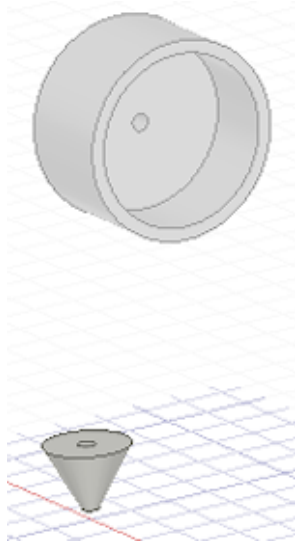

- b. Restore the previously selected *Trimetric* view and the visibility of all objects.

Mirror Objects to Complete the Geometry

To complete the power resistor geometry, you will mirror the wire, solder, and end cap objects about the global XZ plane.

1. Select the **Solder**, **Wire**, and **EndCap** objects.
2. On the **Draw** ribbon tab, click  **Thru Mirror**.
3. Press **F3** to return to the graphical properties entry mode. Then, specify a vector normal to the mirror plane as follows:
 - a. Click exactly at the global origin.
 - b. Click a second grid point lying on the X axis.

The selected objects are mirrored about the plane normal to the X axis (the YZ plane).

4. If the *Properties* dialog box appears, press **Esc** to dismiss it.
5. Clear the selection.



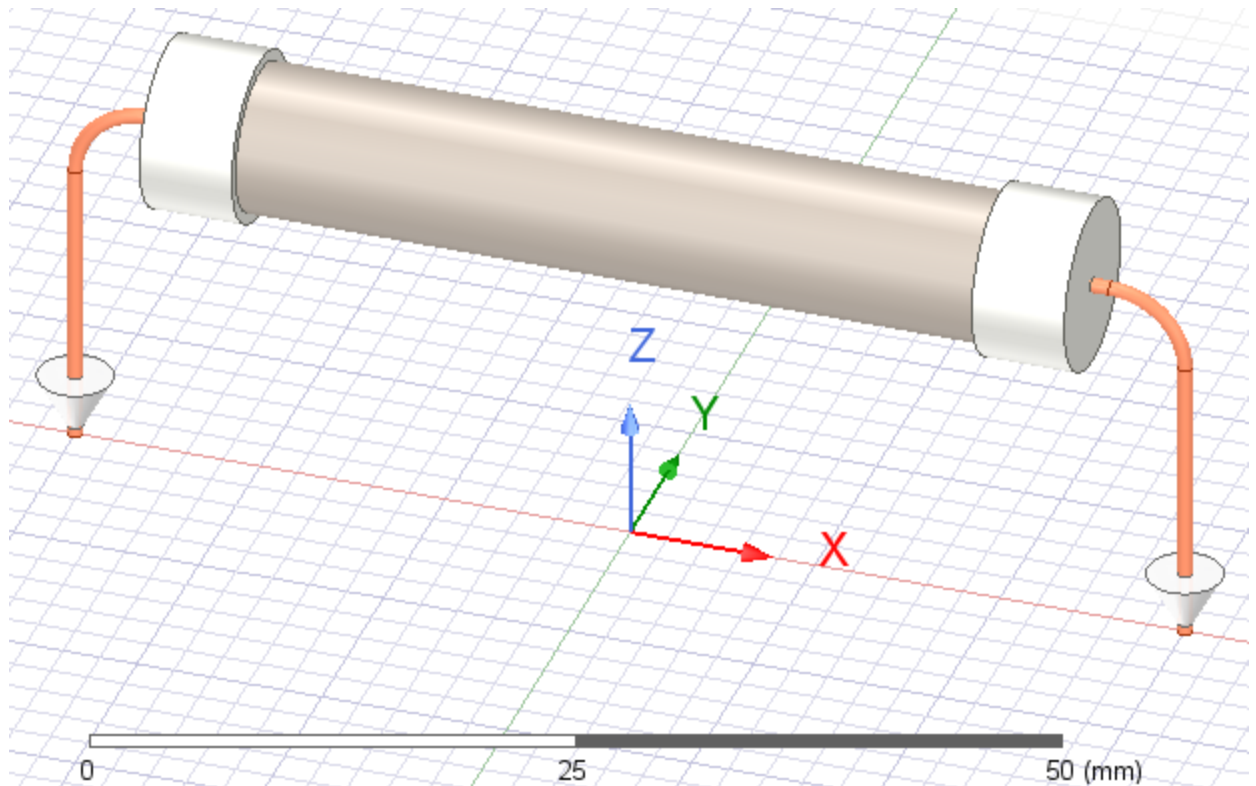

The model should now look like the following image:



The geometry is now complete.

Copy Geometry to Icepak Design

You will duplicate the Mechanical geometry in Icepak. The designs will be identical except that Icepak will automatically add an air region enclosing the solid model geometry. Therefore, the Icepak design will include one additional object.

1. Optionally, since you are done constructing geometry, you may want to hide the grid and ruler, as follows:
 - On the **Draw** ribbon tab, click  **Grid** and  **Ruler** to toggle *off* the visibility of both of these items.
2. Click in the Modeler window and then press **Ctrl+A** to select all objects.
3. Right-click in the Modeler window and choose **Edit > Copy** from the shortcut menu.
4. In the Project Manager, double-click **IcepakDesign1 (SteadyState)** to make this design active.
5. Right-click in the Modeler window and choose **Edit > Paste**.
6. On the **Draw** ribbon tab, click  **Orient > Trimetric**.
7. On the **Draw** ribbon tab, click  **Fit All**.

8. Click in the Modeler window background area to clear the current selection.
9. Optionally, repeat step 1 to hide the grid and ruler in the Icepak design as well.

The coordinate axes can remain visible. They do not obstruct the view of the model and, along with the *View Orientation Gadget*, will aid you in visualizing the direction of air flow when defining the thermal openings in a later procedure.

The model should now look like the following image:

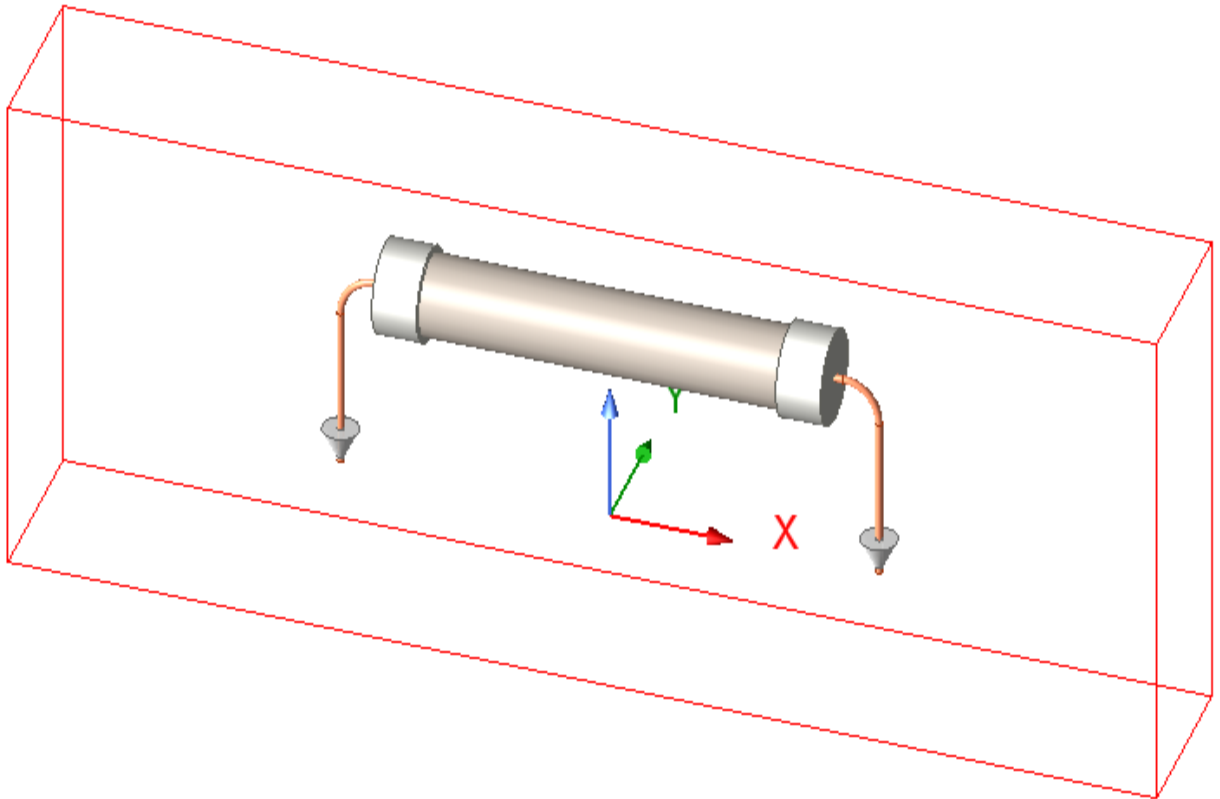

Note:

The **Material** attributes for all solid parts were copied from the Mechanical design along with the geometry.

Icepak includes a **Surface Material** attribute for model objects that is separate from the **Material** attribute. The surface material is only relevant if radiation is included in the solution (because the surface material selection affects the emissivity). Additionally, in the future, turbulent flow may be affected by the roughness of the surface material. However, this feature is not currently implemented for Icepak designs in the Ansys Electronics Desktop application.

Since the solution for this exercise is convection-only (no radiation effects) and is also laminar flow, there is no need to change the default **Surface Material** attribute for any of the solid objects.

Adjust Air Region Size

The air flow for this model will be in the -Y direction (from the back of the air region to the front). The default padding (that is, the distance from the solid geometry to the outer boundaries of the air) is greater than needed in the X direction. Also, because the diameter of the resistor is small compared to its height and length, the padding in the Y direction is limited. It is advantageous to *not* have an inlet or outlet too close to an area where the flow must change direction to circulate around the solid geometry. For this exercise, you will reduce the X padding and increase the Y padding, as follows:

1. Under *Model > Solids > air > Region* in the Project Manager, select **CreateRegion**.
2. In the docked *Properties* window, make the following changes in the **Value** column and press **Enter** after each entry:
 - a. **+X Padding Data = 25**
 - b. **-X Padding Data = 25**
 - c. **+Y Padding Data = 100**
 - d. **-Y Padding Data = 100**

Name	Value	Unit	Evaluated Value
Command	CreateRegion		
Coordinate System	Global		
+X Padding Type	Percentage Offset		
+X Padding Data	25	25	
-X Padding Type	Percentage Offset		
-X Padding Data	25	25	
+Y Padding Type	Percentage Offset		
+Y Padding Data	100	100	
-Y Padding Type	Percentage Offset		
-Y Padding Data	100	100	
+Z Padding Type	Percentage Offset		
+Z Padding Data	50	50	
-Z Padding Type	Percentage Offset		
-Z Padding Data	50	50	

Command

The model should now look like the following image:

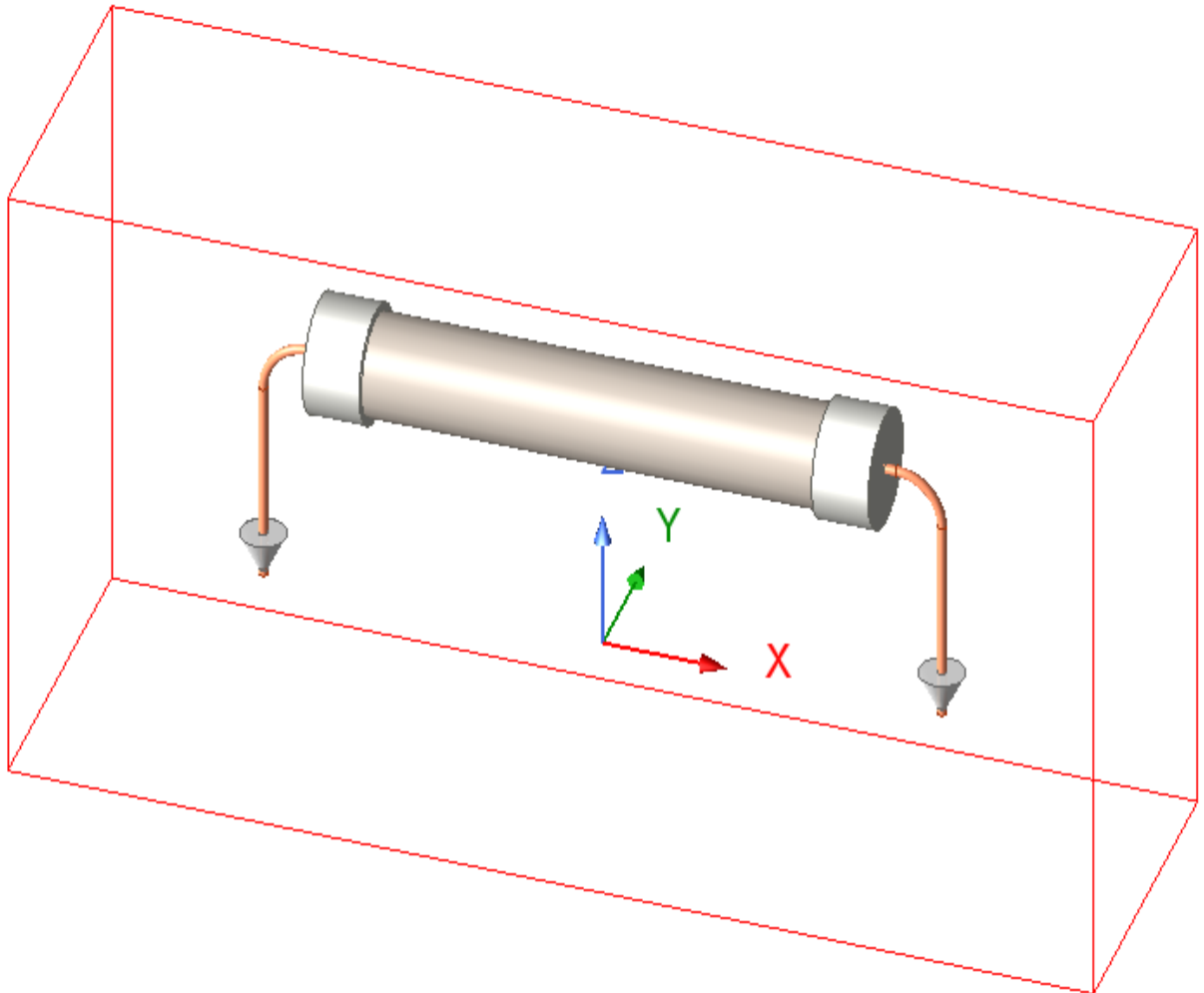

Add Void in Air Region

You will add a void within the air region to account for the circuit board to which the power resistor is mounted. The board itself is not actually included in the model. In a later step, you will assign a negative thermal source to the top of each solder joint to represent heat conducted into the circuit board. These solder faces should *not* be contained within the air flow region for the following two reasons:

- The top face of each solder joint is bonded to the printed circuit board and therefore not exposed to ambient air. The thickness of the void also blocks air flow from a short portion of the wire leads.
- If the top face of each solder joint were contained within the air region, they would be over-constrained, having both a dictated heat flow rate and convective cooling.

The bottom face of the void will be coplanar with the top face of the solder joints. Create the void as follows:

1. On the *Draw* ribbon tab, click  **Draw box**.

Press **F4** to switch back to the dialog box entry mode. Next:

- a. In the **Command** tab of the *Create Box* dialog box, enter the values shown in the following image:

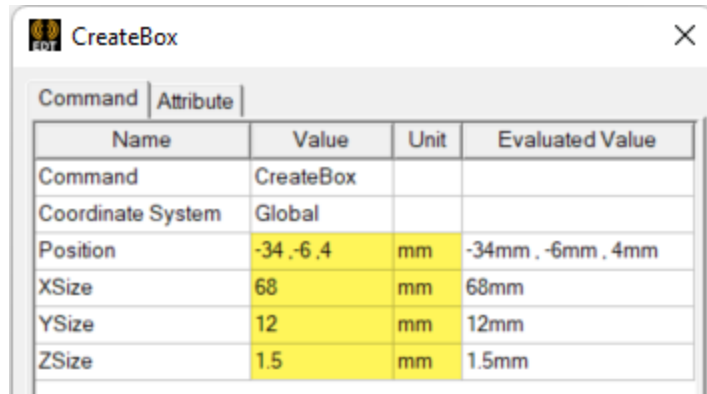

- b. Under the **Attribute** tab of the dialog box, change the object **Name** to **Void**.
 - c. Choose **air** from the **Material** drop-down menu.
 - d. Clear the **Solve Inside** option to prevent air flow within the void.
 - e. Select **Display Wireframe**.
 - f. Ensure that the **Material Appearance** option is cleared.
 - g. Change the **Color** to **Red** (column 1, row 2 of the color samples).
 - h. Ensure that the **Transparent** value is **0** (opaque) for good visibility of the wireframe.
 - i. Press **OK**.
2. Clear the selection and zoom or pan as required for a good view of the model, which should look like the following image:

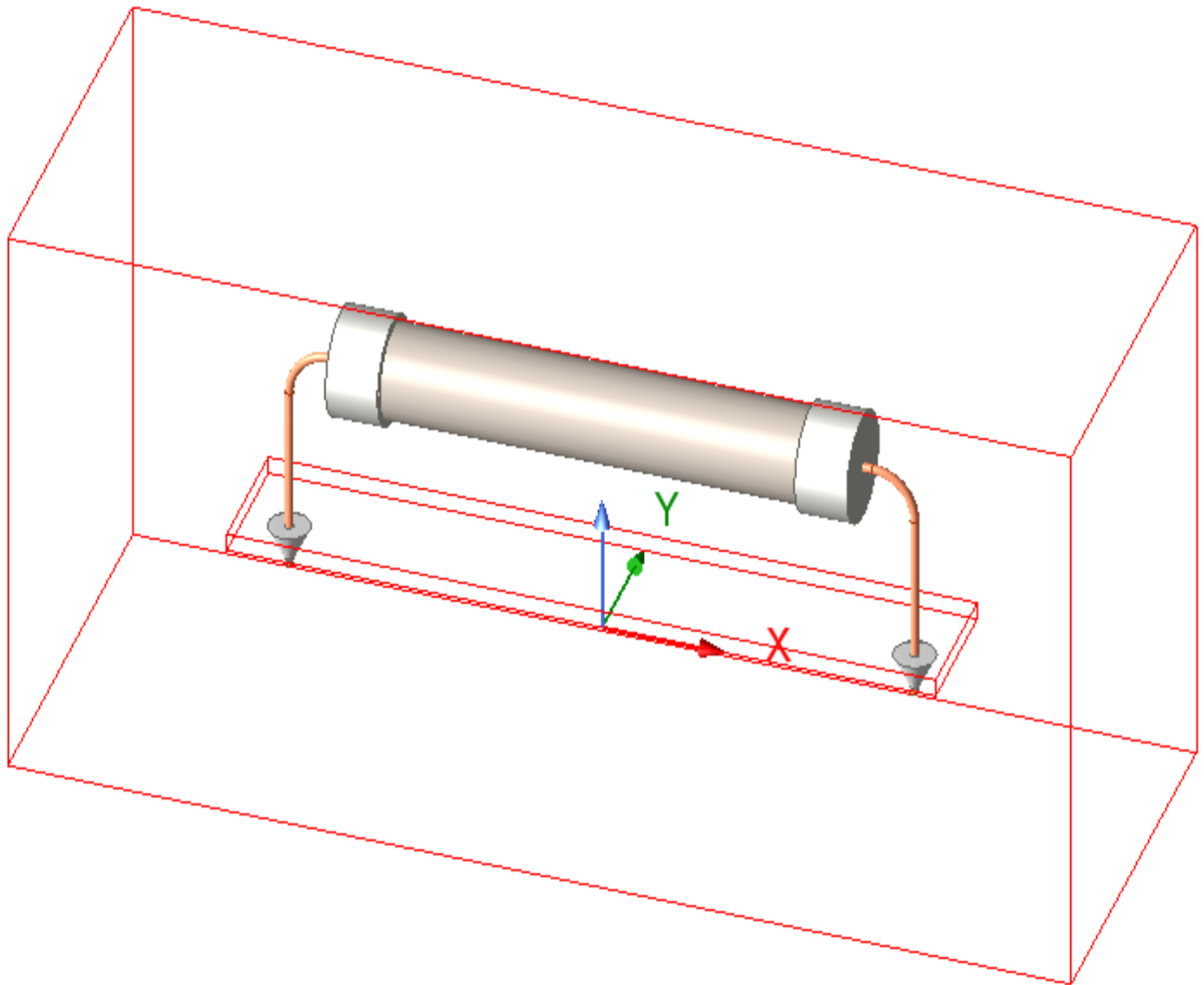

3. Under *Model* > *Solids* in the History Tree, select the following objects:
 - a. Under *copper*: **Wire** and **Wire_3**
 - b. Under *Solder, tin-lead (60-40)*: **Solder** and **Solder_1**

A total of four objects should be selected.

4. On the **Draw** ribbon tab, click  **Object Priority**. Then, in the dialog box that appears, do the following:
 - a. Click **Add Priority List**.

The *Object Priority* dialog box should now match the following image:

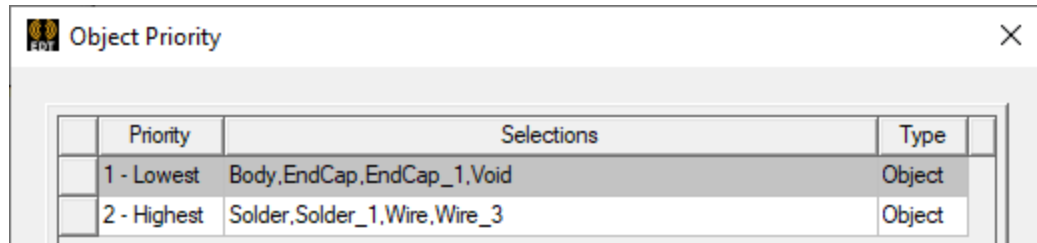

b. Click **OK**.

Note:

- The wire leads must have a higher priority than the void so that the wires take precedence in the region of intersection.
- The solder joints must have a higher priority than the void to ensure that the face at the top of each solder joint, to which a thermal boundary will be assigned, gets meshed. Remember that these faces are coplanar with the bottom face of the void.
- If you had not subtracted the wire leads from the end caps and solder joints when building the geometry, an additional object priority level would be required. Specifically, you could have made the wires alone have the highest priority, the solder the next highest priority, and the void and remaining solid objects the lowest priority. Doing so would ensure that the wires take precedence over all objects they intersect.

4 - Set Up and Solve Icepak Design

In this section, you will complete the following procedures for the Icepak design:

- Assign flow openings
- Assign thermal sources
- Add a solution setup
- Run the simulation
- Create a temperature overlay

Before proceeding to the next topic, complete the following step in the Project Manager:

1. Collapse the **MechanicalDesign1 (Structural)** branch to minimize the chance of performing an operation on the wrong design.

IcepakDesign1 (SteadyState) should already be the active design.

Assign Flow Openings

To create flow in the air region, you will define two openings, one at ambient pressure (the flow inlet) and one with a prescribed X-velocity (the flow outlet).

1. Press **F** to switch to the *Face* selection mode.
2. Click the **front face** (-Y side) of the air region.
3. In the Project Manager, right-click **Thermal**, under *IcepakDesign1 (SteadyState)*, and choose **Assign > Opening > Free** from the shortcut menu. Then, in the *Opening Thermal Model* dialog box, do the following:

- a. Change the **Name** to **Outlet**.

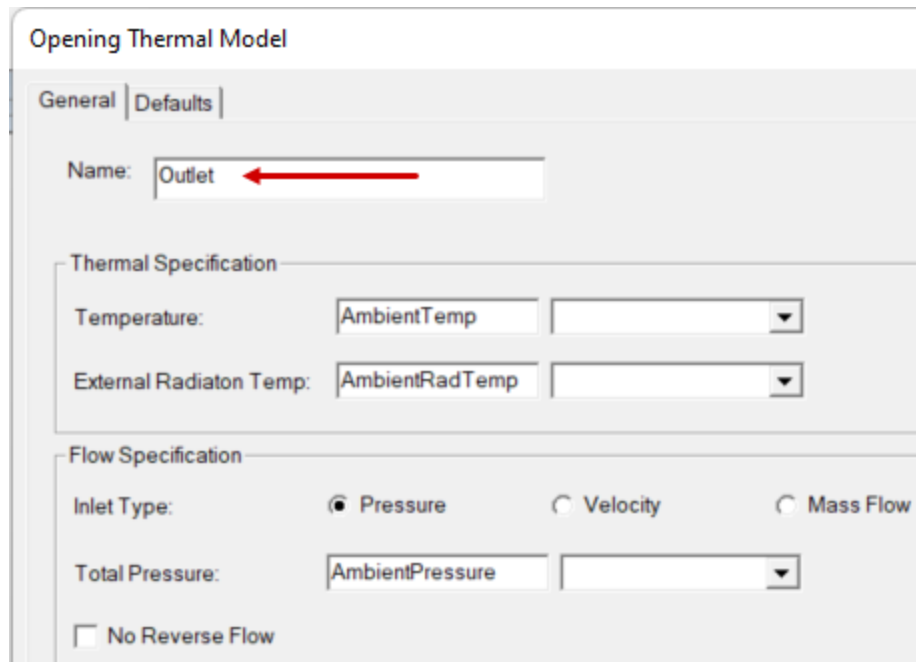

- b. Click **OK** to accept the remaining default settings.
4. Click near the middle of the air region's **top face**. Then, press **B** to select the *Next Behind* face, which is the back (+Y side) of the air region.
5. Right-click in the Modeler window and choose **Assign Thermal > Opening > Free**. Then, in the *Opening Thermal Model* dialog box, do the following:
 - a. Change the **Name** to **Inlet**.
 - b. Under *Flow Specification*, select **Velocity** as the **Inlet Type**.
 - c. For the **Y Velocity**, specify **-0.5 m_per_sec**.

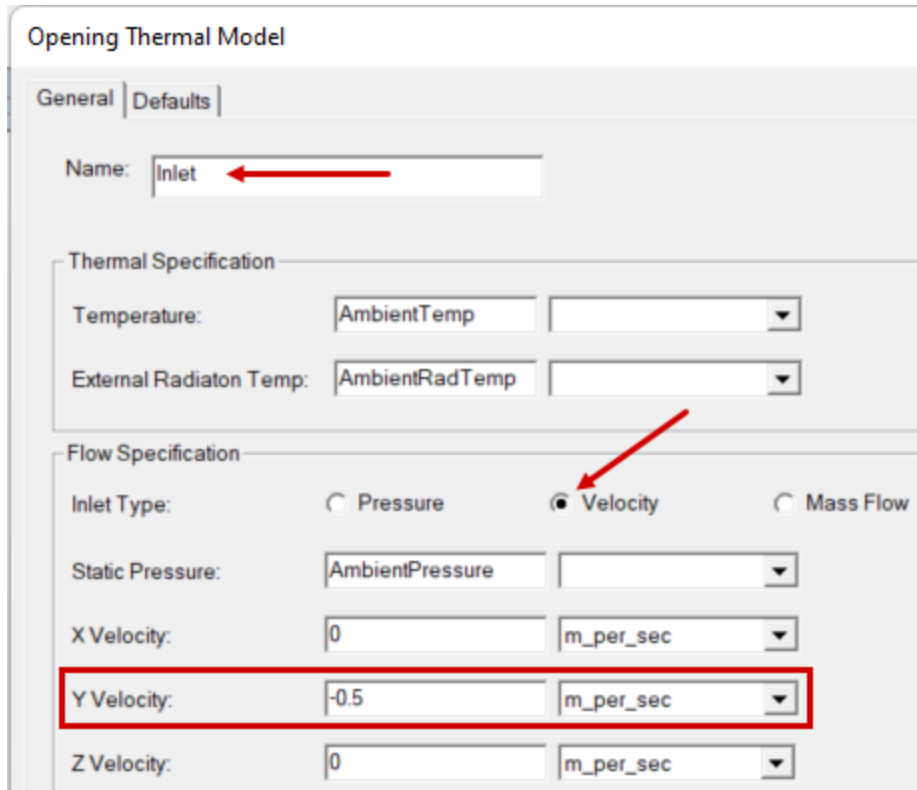

d. Click **OK**.

Inlet and *Outlet* appear under *Thermal* in the Project Manager:

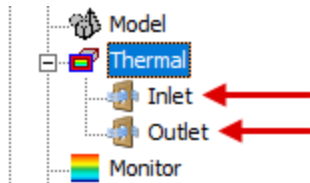

6. Select each of the two openings, one at a time, to see them visualized in the Modeler window:

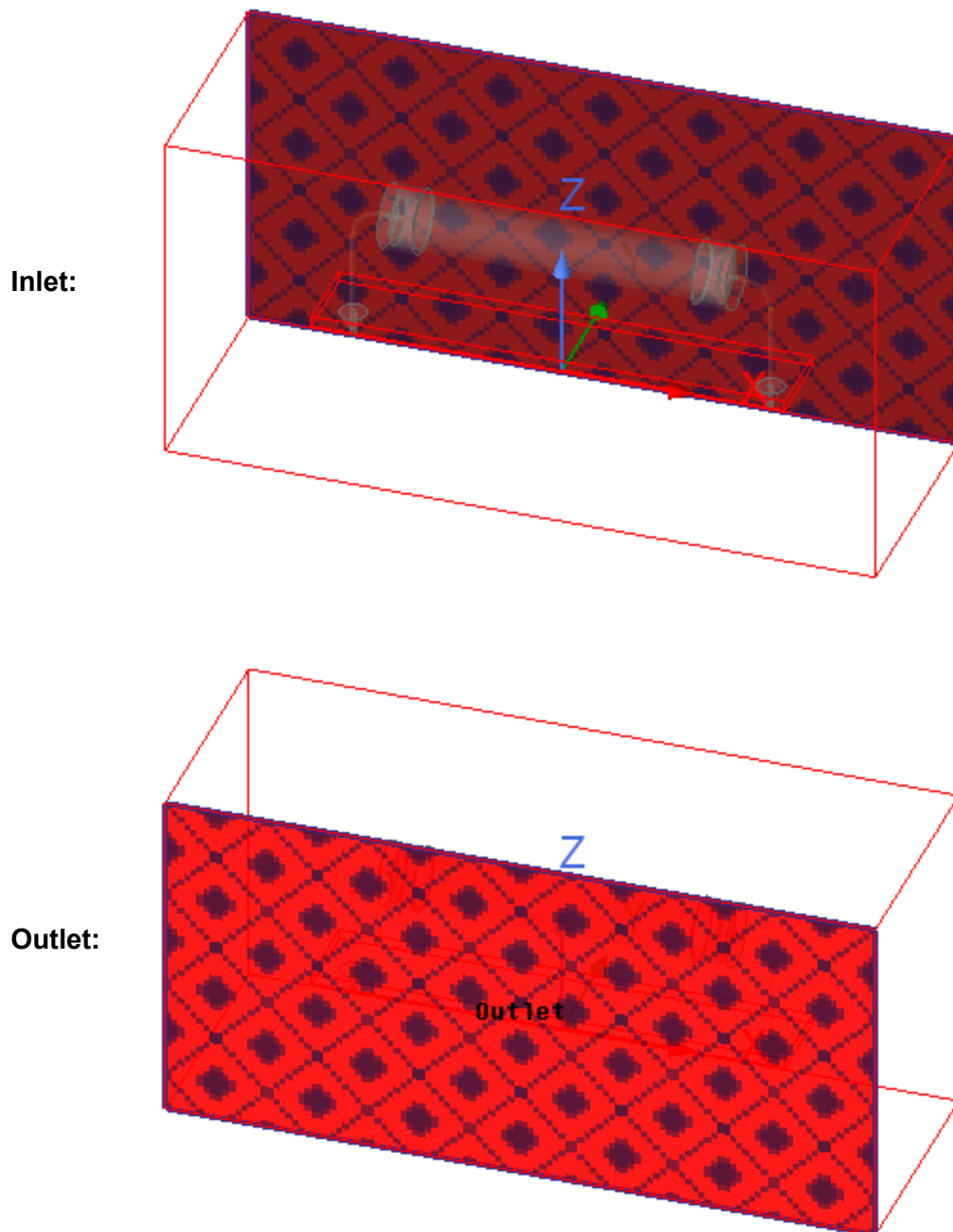

Selection of model objects and faces will be easier in upcoming procedures if the air region and the void within it are hidden. Since you are done defining these objects and the boundaries assigned to the region faces, you can hide them now.

7. Under *Model* > *Solids* > *air* in the History Tree, select both **Region** and **Void**.
8. On the **Draw** ribbon tab, click  **Hide selected objects in active view**.

Only the resistor assembly and solder joints should remain visible.

Assign Thermal Sources

The body of the resistor generates 7.5 watts of heat. Additionally, an estimated 1 watt of heat conducts into the circuit board (0.5 W per solder joint face). The remaining 6.5 watts of heat is dissipated by the air region through forced convection.

You will assign a positive 7.5 W thermal source to the resistor body and a negative 0.5 W thermal source to the circular face of each solder joint, as follows:

1. While still in **Face** selection mode, click the top, circular face of the left solder joint. Then, **Ctrl+click** the top, circular face of the right solder joint to select it too:

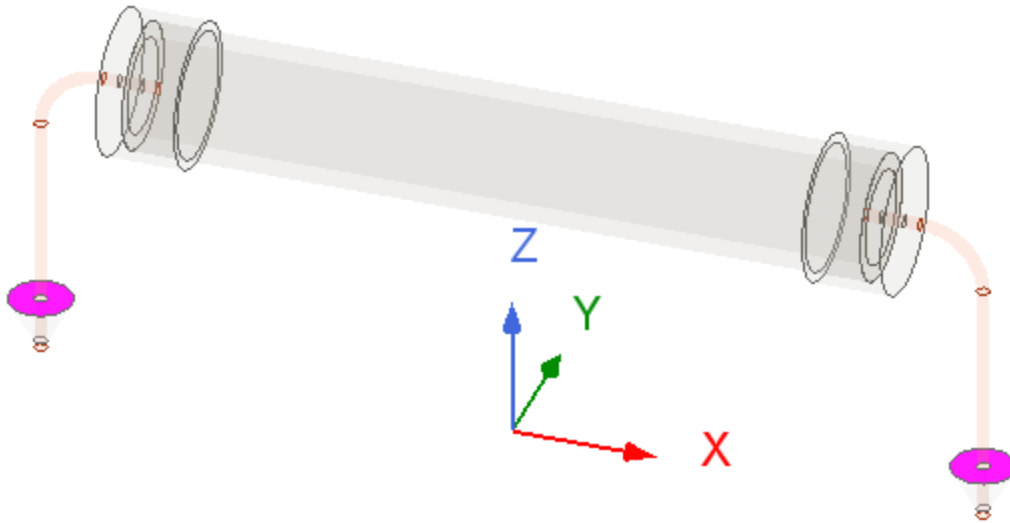

2. Right-click **Thermal** in the Project Manager and choose **Assign > Source**. Then, in the *Source Thermal Model* dialog box that appears, do the following:
 - a. Change the **Name** to **Sink_0.5W**.
 - b. For the **Total Power**, specify **-0.5 W**.

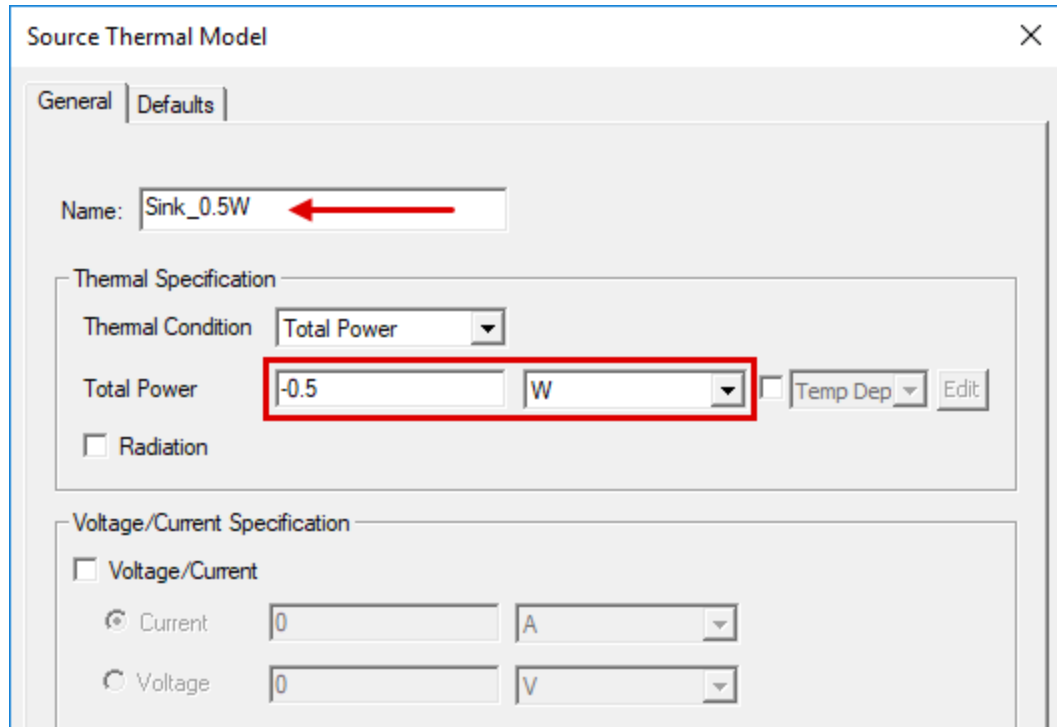

Note:

A negative power value removes heat from the model.

The specified *Total Power* is per selected entity. Therefore, since two faces are selected, this assignment removes 1 watt of heat from the model (2 * 0.5 W).

- c. Click **Finish**.
3. In **Object** selection mode, select the resistor body:

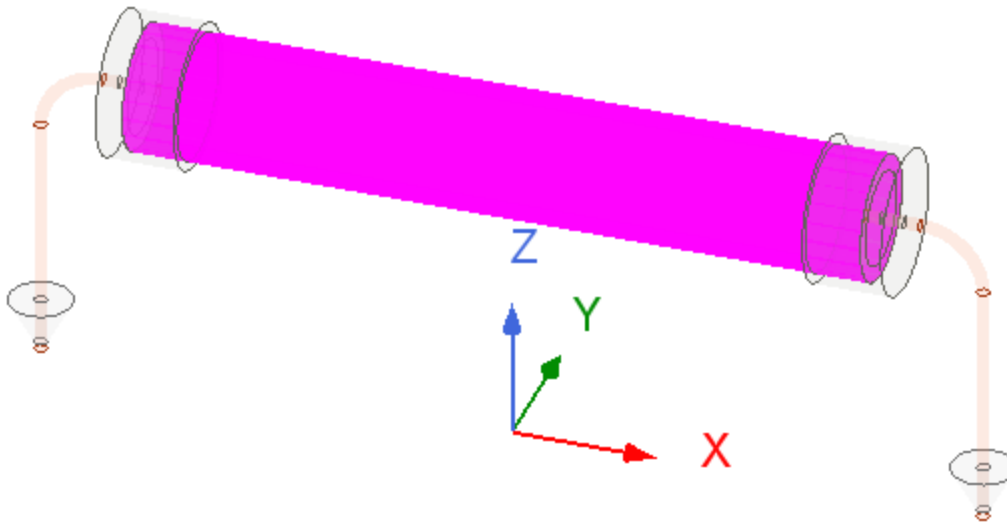

4. Right-click in the Modeler window and choose **Assign Thermal > Source**. Then, in the *Source Thermal Model* dialog box, do the following:
 - a. Change the **Name** to **Source_7.5W**.
 - b. For the **Total Power**, specify **7.5 W**.

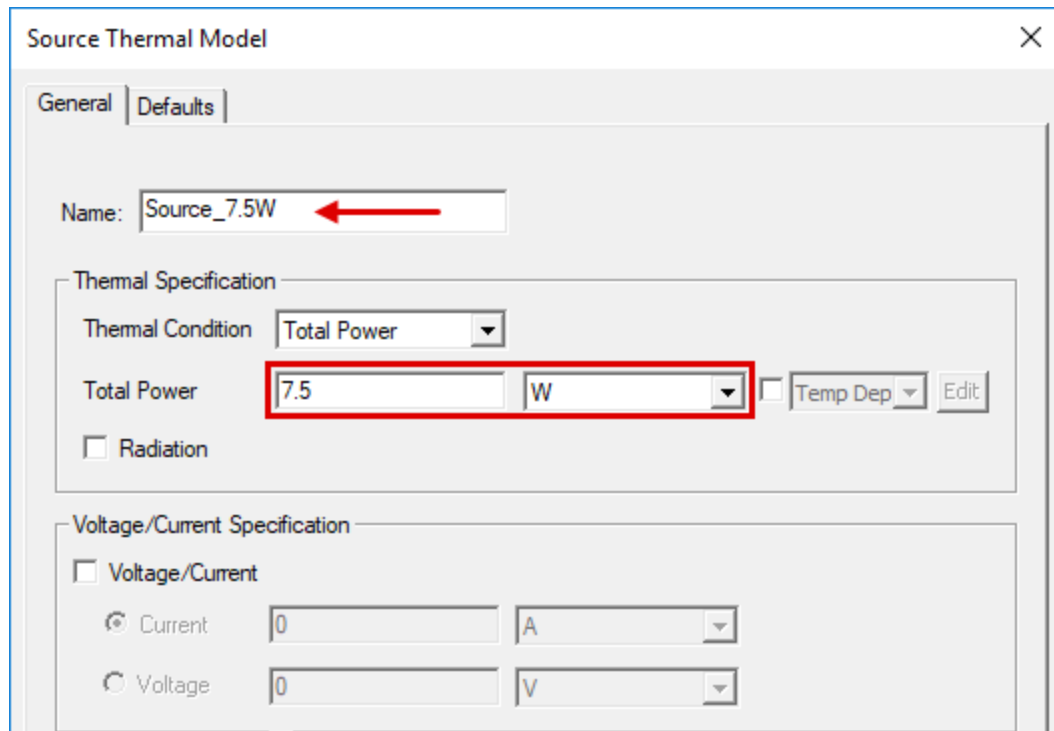

- c. Click **Finish**.

Sink_0.5W and *Source_7.5W* appear under *Thermal* in the Project Manager:

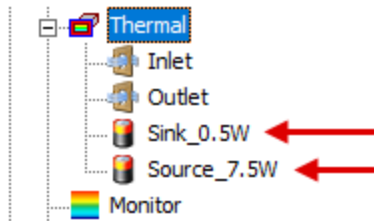

Add Solution Setup and Solve

Add a solution setup using forced convection default settings and then validate and run the steady-state thermal analysis, as follows:

1. Right-click **Analysis** in the Project Manager and choose **Add Solution Setup** from the shortcut menu. Then, in the *Icepak Solve Setup* dialog box that appears, do the following:
 - a. From the **Solve Setup Defaults** drop-down menu, select **Forced Convection Defaults**:

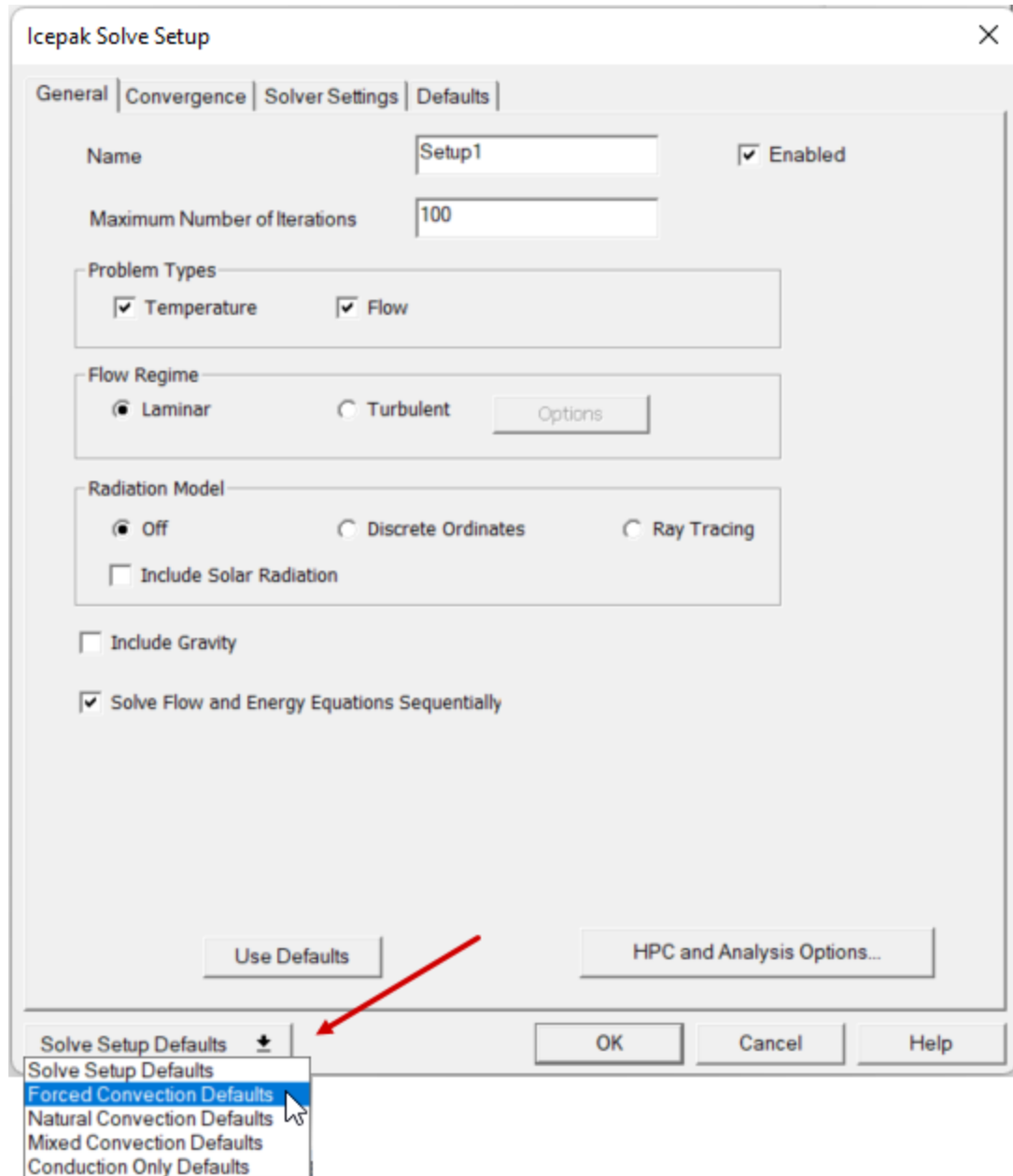

b. Click **OK**.

2. On the **Simulation** ribbon tab, click  **Validate**. Then:

a. Verify that there are no warnings or errors reported in the *Validation Check* dialog box:

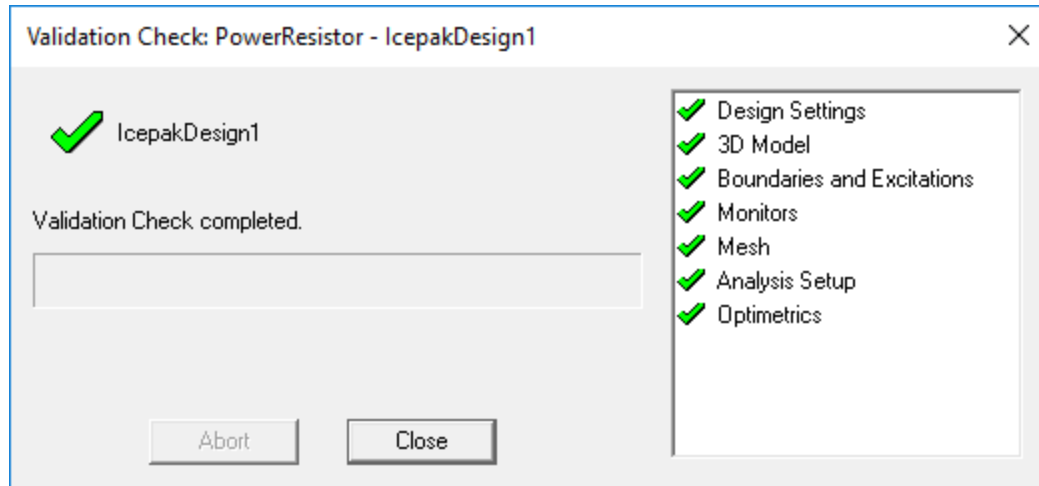

If there are warnings or errors, recheck your work.

b. Click **Close**.

3. On the **Simulation** ribbon tab, click  **Analyze All**.

The solution should take only a minute or two to complete on a reasonably current computer workstation.

4. Under *Analysis* in the Project Manager, right-click **Setup1** and choose **Residual**. Then, in the *Residual* tab of the *Solutions* dialog box, do the following:

a. Verify that the solution completed in under 100 iterations (the specified limit), indicating that the solution converged:

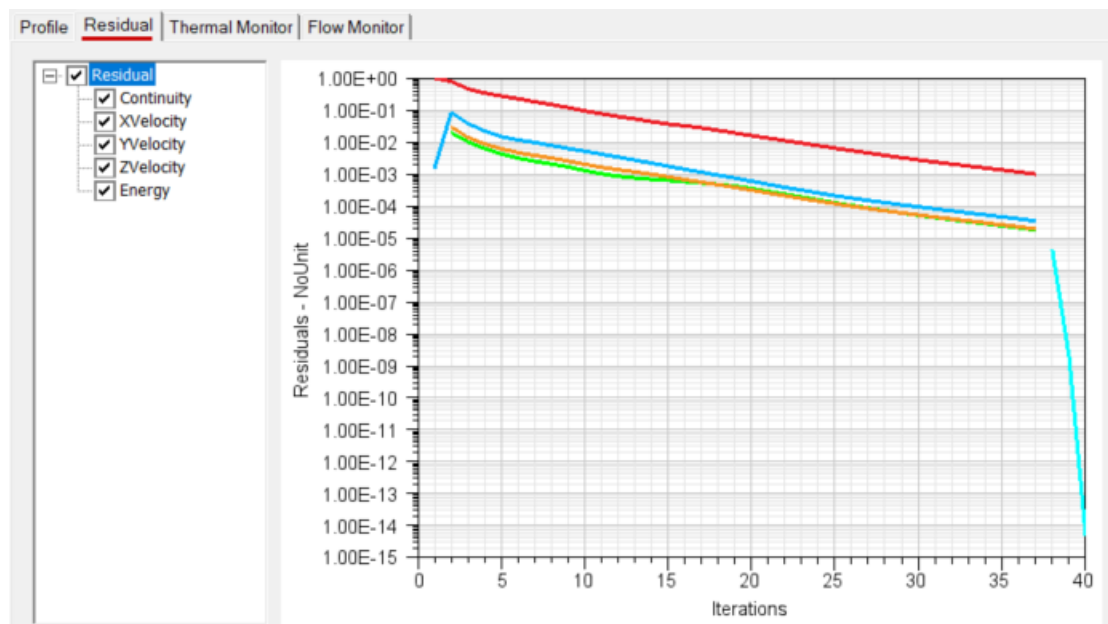

Note:

In the preceding residual graph, the *Continuity* convergence criterion (0.001, red curve) was satisfied in the 37th iteration. The *Energy* convergence criterion (1E-12, cyan curve) was satisfied and surpassed in the 40th iteration (well under the 100 iteration limit).

Your results may differ somewhat from the above residual graph.

- b. Click **Close**.

Create Temperature Overlay

As your last procedure for the Icepak design, create a temperature overlay plotted on the surface of all solid objects. You will later verify the integrity of the temperatures imported into the Mechanical design by comparing them to the Icepak results.

1. In **Object** selection mode, click in the Modeler window and press **Ctrl+A** to select all visible objects.
2. In the Project Manager, right-click **Field Overlay** and choose **Plot Fields > Temperature > Temperature**. Then, in the *Create Field Plot* dialog box that appears, do the following:

- a. Select the **Plot on surface only** option:

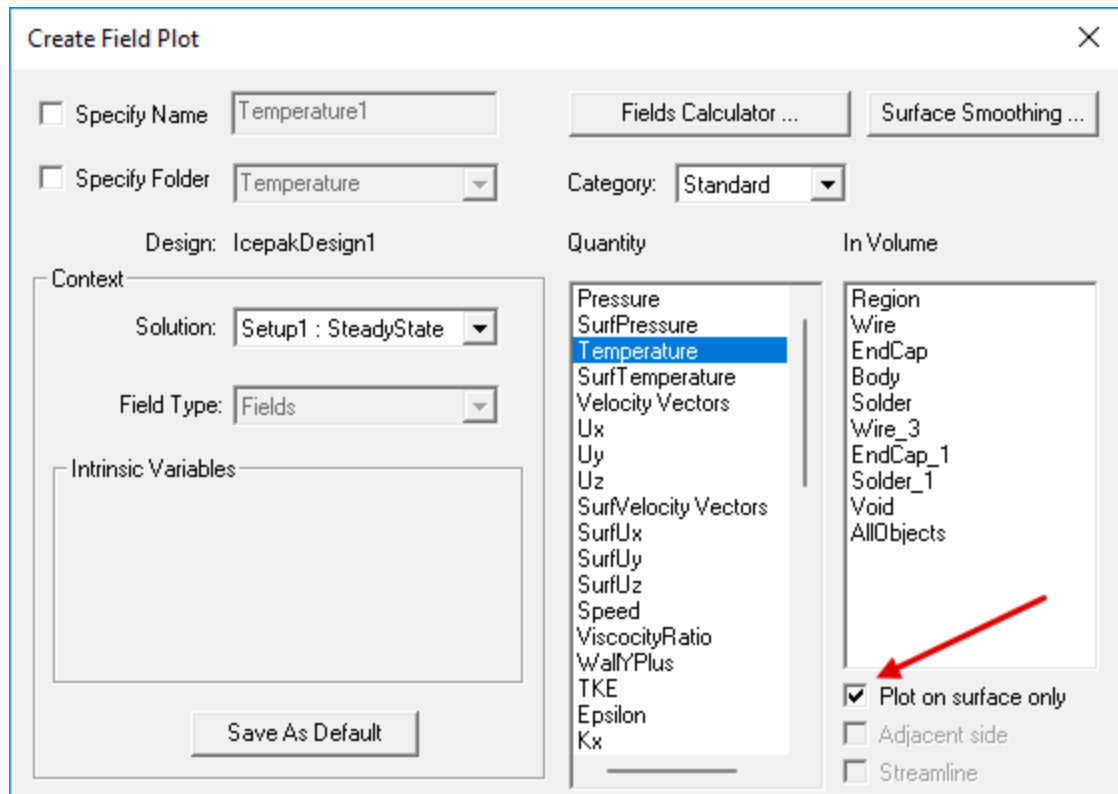

- b. Click **Done**.

Note:

Even though you are plotting the object temperature results only on the surfaces, you were instructed to choose the *Temperature* overlay rather than the *SurfTemperature* overlay. The latter uses a different method of calculating the surface temperature contours than is available for the Mechanical solution. The first choice ensures an apples-to-apples comparison of the Icepak and Mechanical temperatures.

- Optionally, using the menu bar, click **View > Coordinate System > Hide** for a cleaner display of the results.
- For the best overlay appearance, especially on curved surfaces, press **F6** to switch the CAD rendering mode to *Wireframe*, removing the CAD surface shading.

The resultant overlay should resemble the following image:

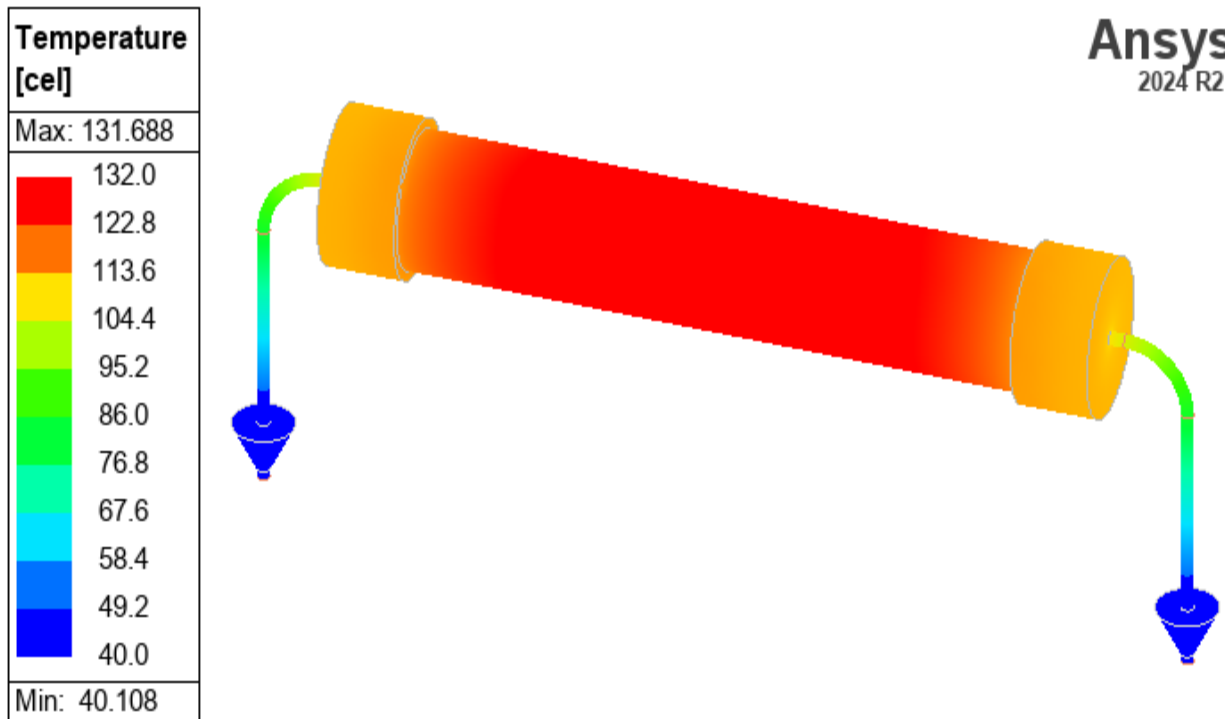

Make a note of the temperature range shown in the plot legend (approximately 40.1° C to 131.7° C).

5 - Set Up and Solve Mechanical Design

In this section, you will switch back to the Mechanical design and perform the following tasks:

- Assign fixed support boundaries
- Assign thermal condition excitation
- Add solution setup and solve

Before proceeding to the next topic, complete the following two steps in the Project Manager:

1. Double-click **MechanicalDesign1 (Structural)** to make it the active design.
2. Collapse the **IcepakDesign1 (SteadyState)** branch to minimize the chance of performing an operation on the wrong design.

"

Assign Fixed Supports

Structural solutions are linear static thermal stress analyses. As such, the model must be statically stable. That is, the geometry must not be free to translate freely in any direction. A fixed support boundary prevents motion in all three global directions for the faces to which it is assigned. For this model, you will fix the top, circular faces of each solder joint, which is where the solder would interface with the printed circuit to which it is mounted.

You could assign a single constraint to both faces. However, in a later step we will include a report of the *Reaction Force* at each support. If combined into a single support, the sum of the reaction forces will be zero in all directions for a linear static analysis. Assigning separate supports to each face will cause the components of the total reaction force to be reported separately for each support. We expect to see reaction forces in the plus and minus X direction opposing the thermal elongation of the resistor assembly. +/- Y reactions should cancel out as the wire and solder expand equally in all directions. Z reactions should theoretically be zero since the weight (that is, the effect of gravity) is not currently supported for structural solutions and is therefore not included. Also, Z forces due to bending moments in the wires should produce negative and positive nodal reactions at each joint, which cancel out.

Assigning the two fixed supports as follows:

1. Press **F** to switch to the *Face* selection mode.
2. Click the **top face** of the *left* solder object.

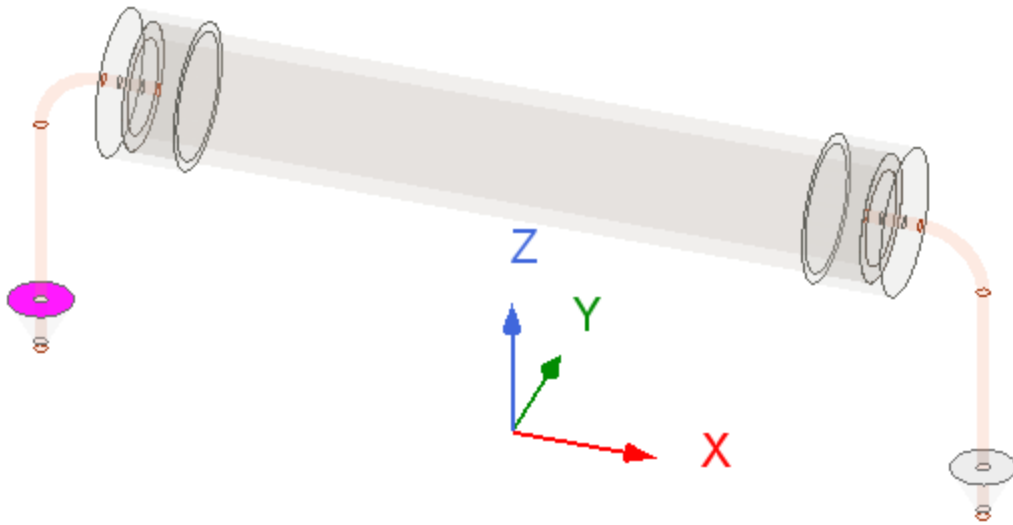

3. In the Project Manager, right-click **Boundaries** and choose **Assign > Fixed Support** from the shortcut menu. Then:
 - Click **OK** to accept the default *Name* and to assign the fixed support.
4. Repeat steps 2 and 3, this time selecting the top face of the *right* solder joint.

FixedSupport1 and *FixedSupport2* are listed under *Boundaries* in the Project Manager.

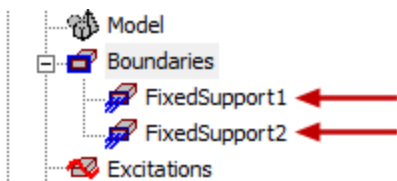

5. Momentarily select **FixedSupport1** and **FixedSupport2** to see each visualized on the model:

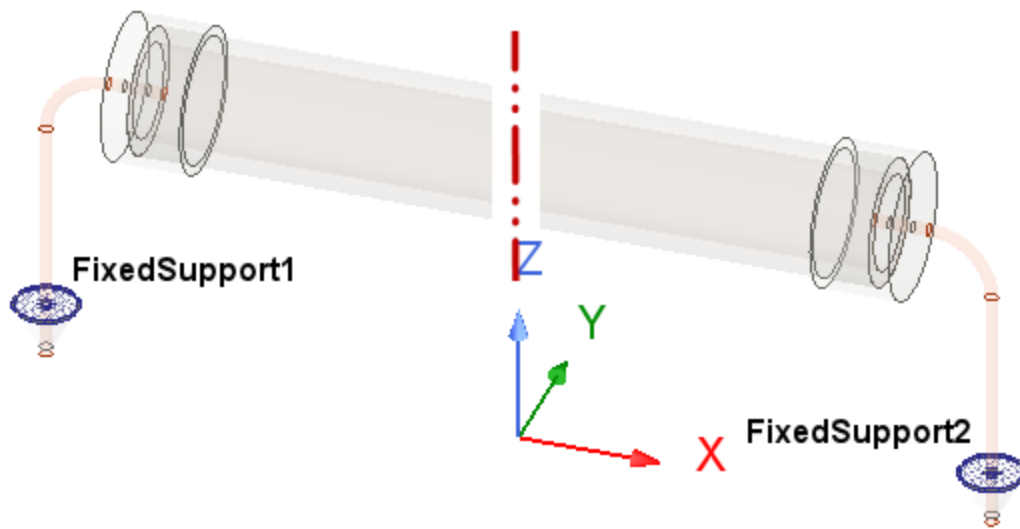

6. Clear the selection.

Assign Thermal Condition

Thermal condition excitations can be defined as uniform (a fixed, user-defined temperature) or non-uniform (an imported temperature distribution from the results of a source design solution). You will assign a non-uniform thermal condition to all objects and link to the Icepak solution results, as follows:

1. Press **O** to switch to the *Object* selection mode.
2. Click and drag to form a selection rectangle enclosing the entire model to select all objects:

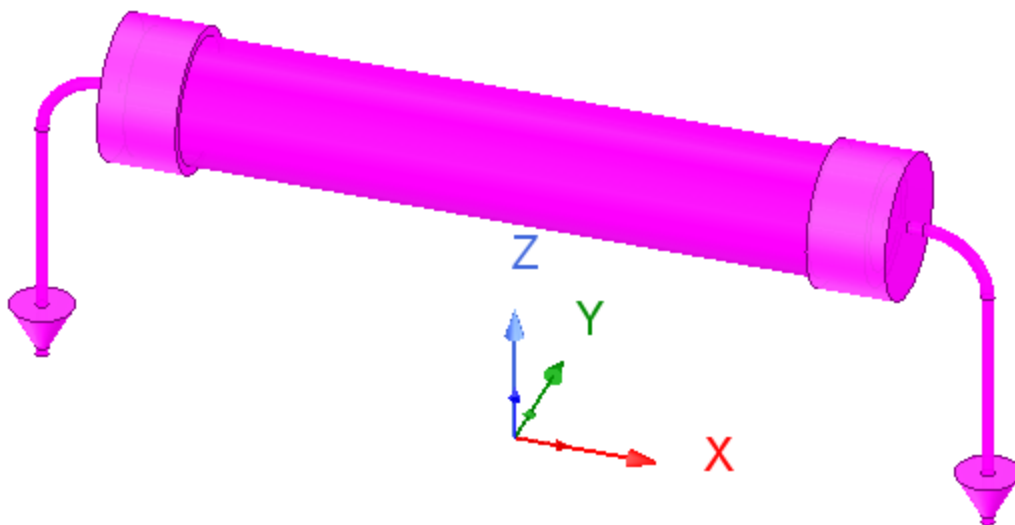

3. Right-click in the Modeler window and choose **Assign Excitation > Thermal Condition** from the shortcut menu. Then, in the *Thermal Condition* dialog box, do the following:
 - a. Select the **Non-Uniform** option.

In the *Setup Link* dialog box that appears, do the following:

- i. In the *Source Project* section, select **Use This Project**.

The Icepak design and setup are selected automatically:

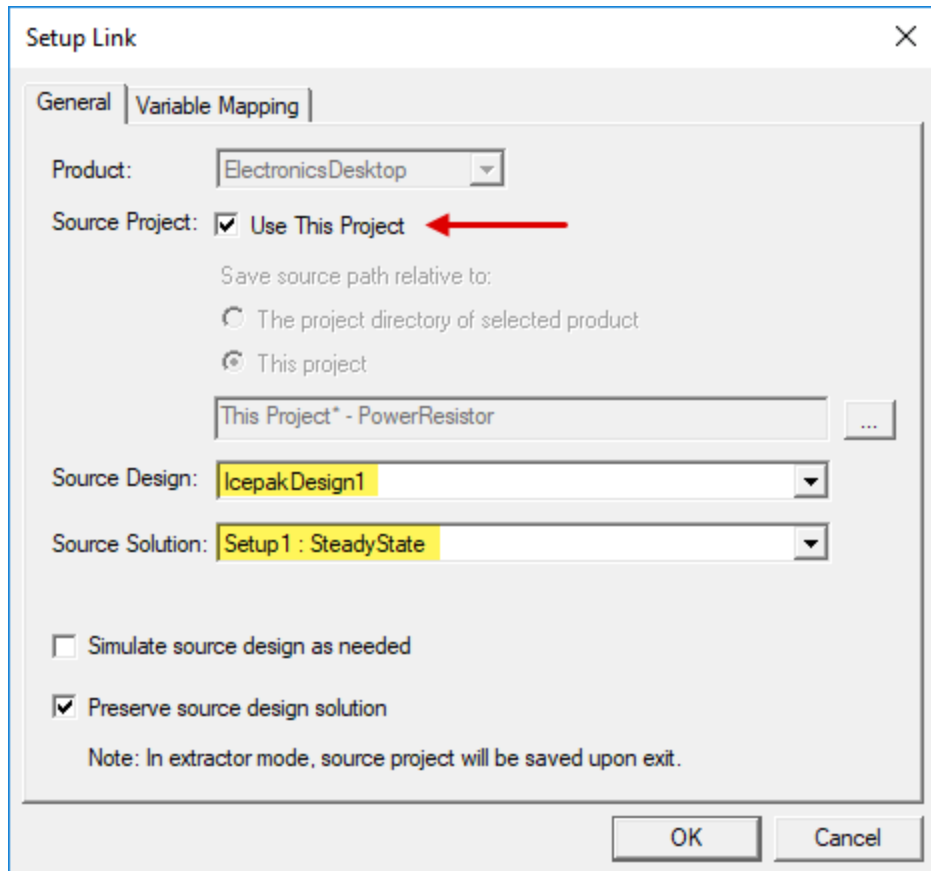

- ii. Click **OK** to close the *Setup Link* dialog box.
- b. Click **OK** to accept and assign the thermal condition excitation.

ThermalCondition1 appears under *Excitations* in the Project Manager:

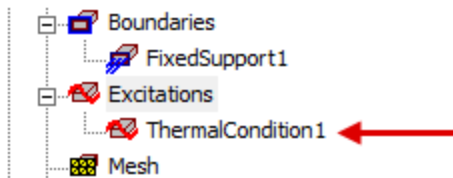

4. Momentarily select **ThermalCondition1** to see it visualized on the model:

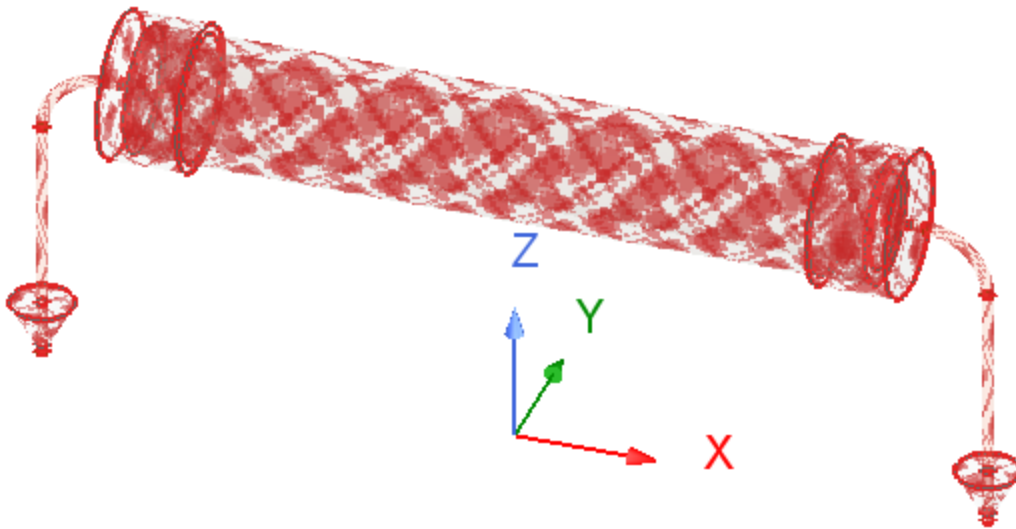



5. Clear the selection.

Add Solution Setup and Solve

Add a solution setup using default settings and then validate and run the structural analysis, as follows:

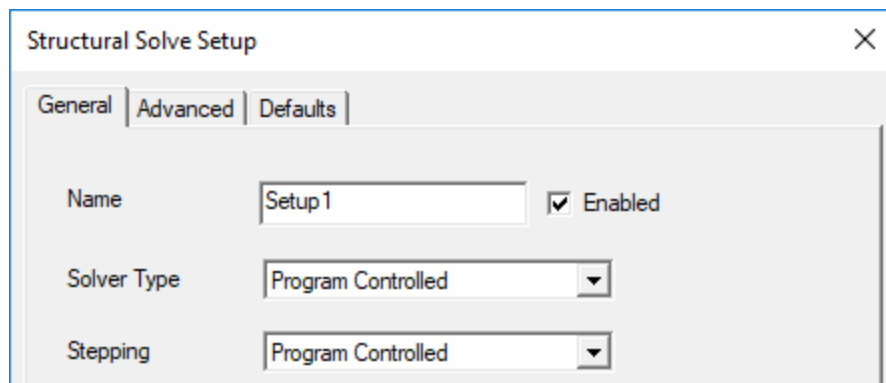
1. Right-click **Analysis** in the Project Manager and choose **Add Solution Setup** from the shortcut menu. Then, in the *Structural Solve Setup* dialog box that appears, do the following:
 - a. Verify that your default settings match those shown in the following image:



- b. Click **OK**.
2. On the **Simulation** ribbon tab, click  **Validate**. Then:
 - a. Verify that there are no warnings or errors reported in the *Validation Check* dialog box:

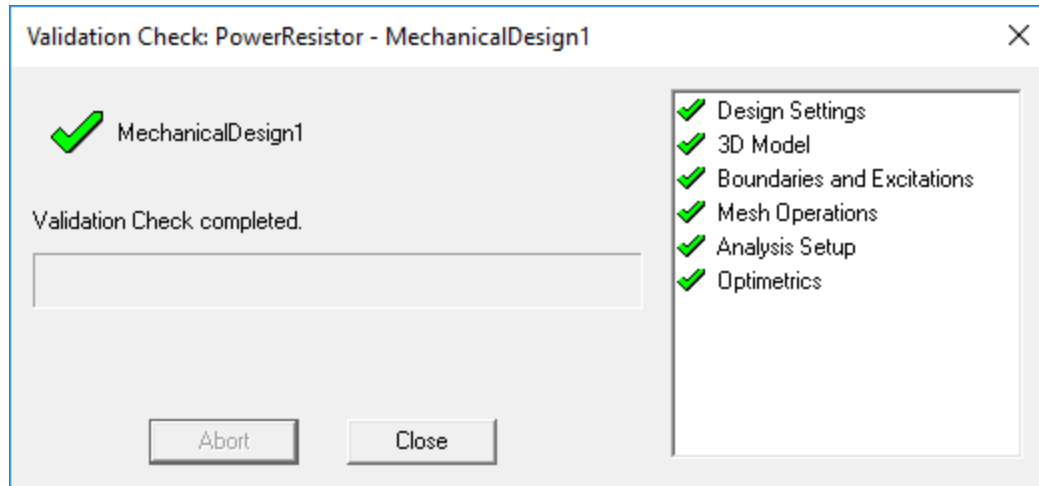

If there are warnings or errors, recheck your work.

b. Click **Close**.

3. On the **Simulation** ribbon tab, click  **Analyze All**.

Due to the mesh refinement, a relatively high element count is expected. The solution takes approximately fifteen minutes to complete using eight-cores of a reasonably current twelve-core computer workstation.

4. Under *Analysis* in the Project Manager, right-click **Setup1** and choose **Profile**. Then, in the *Solutions* dialog box, do the following:
- Notice the step in the solution process where the thermal load was imported from IcepakDesign1 and the total solution time:

Getting Started with Mechanical: Structural Solution – Power Resistor

Task	Real Time	CPU Time	Memory	Information
Solution Process				Start Time: 03/11/2024 14:43:40, Host: AAP\XDHOP8KMAS3, Processor: 16, Executing From: C:\Program Files\AnsysEM\v242\Win64\MECHANICAL\COME
HPC				Type: Manual, Distribution Types: Variations
Machine				Name: AAP\XdHoP8KMas3.win.ansys.com, Tasks: 1, Cores: 4
Design Validation				Level: Perform full validations, Elapsed Time: 00:00:00, Memory: 68.8 M
Meshing Process				Time: 03/11/2024 14:43:40
Mesh	00:00:03	00:00:04	114 M	Tetrahedra: 27909, Type: TAU, Cores: 4
Coarsen	00:00:03	00:00:03	114 M	Tetrahedra: 21292
Post	00:00:02	00:00:01	117 M	Tetrahedra: 37929, Cores: 1
Initial Refine	00:00:17	00:00:16	124 M	Tetrahedra: 95696
Convert	00:00:03	00:00:00		
Meshing Process	00:00:28	00:00:24		Elapsed Time: 00:00:31
Retrieve ThermalCondition1	00:00:06	00:00:02		Type: Thermal Load, Source: This Project%, IcepakDesign1 - Setup1 : SteadySt
Populate Solver Input	00:00:01	00:00:00	0 K	
Solve	00:00:16	00:00:21	418 M	Type: Program Controlled, Core: 4
Solution Process	00:00:51	00:00:47		Elapsed Time: 00:01:11, ComEngine Memory: 298 M Stop Time: 03/11/2024 14:44:51, Status: Normal Completion

- b. Select the **Mesh Statistics** tab.

Here, you can see the total number of tetrahedral elements solved along with a per object tabulation of the element count and other statistics:

Profile Mesh Statistics								
Total number of elements: 38747								
	Num Tets	Min edge length	Max edge length	RMS edge length	Min tet vol	Max tet vol	Mean tet vol	Std Devn [vol]
Body	12481	0.542376	1.74381	1.29	0.000665568...	0.343279...	0.0818696	0.04822
EndCap	4813	0.252555	1.52253	0.907354	0.000101662...	0.114261...	0.0319811	0.0174328
EndCap_1	4751	0.280237	1.66451	0.903521	0.000314067...	0.113996...	0.0323984	0.0168518
Solder	1924	0.201134	1.10352	0.637424	0.000123667...	0.0499826...	0.00723187...	0.0070925
Solder_1	1866	0.132846	0.905976	0.630608	4.54796e-05...	0.0479166...	0.00745665...	0.00765966
Wire	6500	0.19021	1.07124	0.539381	1.39845e-05...	0.0309824...	0.00196569...	0.00277618
Wire_3	6412	0.135283	1.15159	0.548712	1.14306e-05...	0.0340292...	0.00199266...	0.00288395

- c. Click **Close**.

6 - Evaluate Structural Results

In this final section, you will verify the accuracy of imported temperatures and create two additional results overlays. Specifically, you will complete the following three procedures:

- Create temperature overlay and compare to Icepak results
- Create and animate displacement magnitude overlay
- Create equivalent stress overlay
- Create fields summary (eq. stress, eq. strain, and reaction forces)

Create Temperature Overlay

Create a temperature overlay plotted on the surface of all solid objects and compare to the Icepak temperature results.

1. In **Object** selection mode, click in the Modeler window and press **Ctrl+A** to select all visible objects.
2. In the Project Manager, right-click **Field Overlay** and choose **Plot Fields > Temperature**. Then, in the *Create Field Plot* dialog box that appears, do the following:
 - a. Ensure that **Plot on surface only** is selected and other settings match the following image:

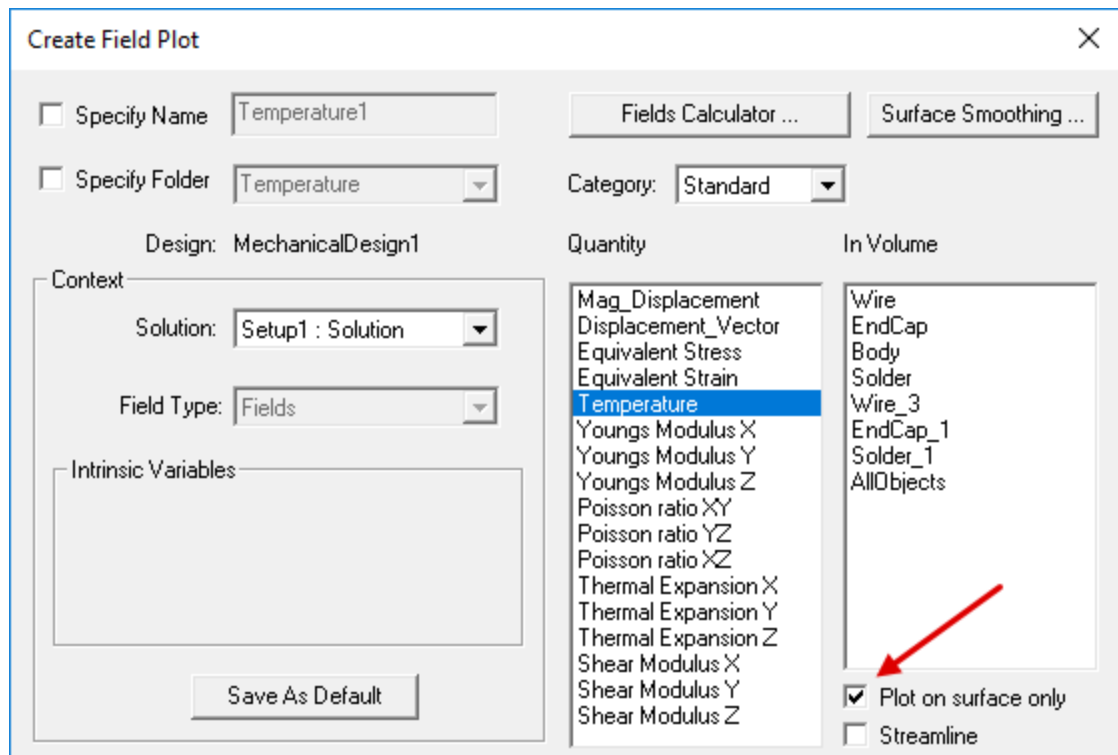

- b. Click **Done**.
3. Under **Field Overlays** in the Project Manager, right-click **Temperature** and select **Modify Attributes**. Then, in the dialog box that appears, do the following:
 - a. Select the **Deformation Scale** tab.
 - b. Clear the **Scale Deformation** option to display only the undeformed model:

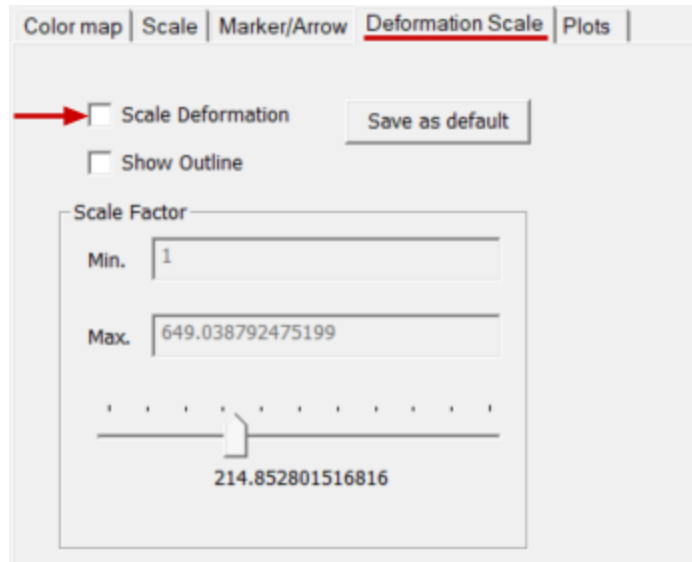

- c. Click **Close**.
4. Optionally, using the menu bar, click **View > Coordinate System > Hide** for a cleaner display of the results.
5. For the best overlay appearance, especially on curved surfaces, press **F6** to switch the CAD rendering mode to *Wireframe*, removing the CAD surface shading.

The resultant overlay should resemble the following image:

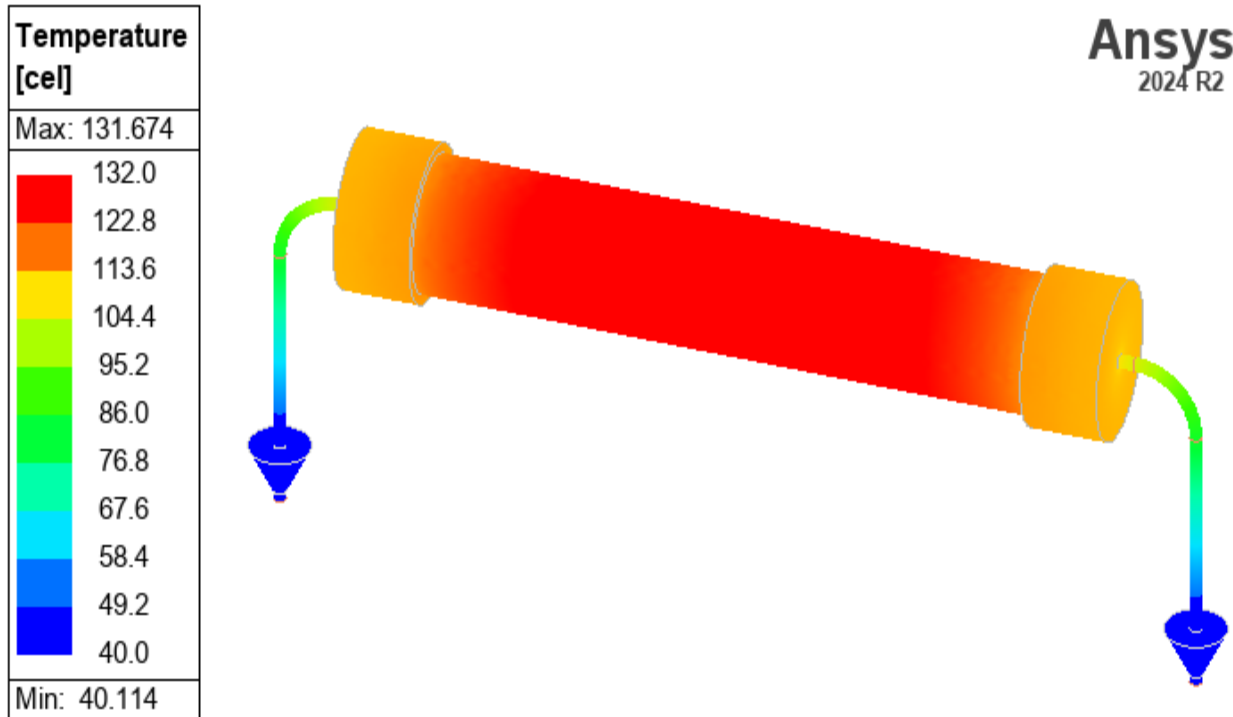
**Observations:**

The range of temperatures in the legend is approximately 40.1° C to 131.7° C. In fact, the minimum and maximum temperature values agree within 0.01° C when compared to the earlier Icepak temperature overlay. The appearance of the color contours is identical. Despite the very different mesh characteristics between these two design types, the temperatures were mapped very accurately.

Create and Animate Displacement Overlay

To see the deformed shape of the power resistor, create an overlay of the displacement magnitudes and animate the overlay. The deformation will be exaggerated for easy visibility, since the actual displacements are very small.

1. Under **Field Overlays > Temperature** in the Project Manager, right-click **Temperature1** and clear the **Plot Visibility** option.

It is best to have only one overlay at a time visible.

2. Once more, right-click **Temperature1** but, this time, choose **Select Assignment**.

Since the temperature overlay was assigned to all solid objects, this method is a convenient way to reselect the same objects.

3. In the Project Manager, right-click **Field Overlays** and choose **Plot Fields > Displacement > Mag_Displacement** from the shortcut menu. Then:
 - a. Verify that the settings in the *Create Field Plot* dialog box that appears match the following image:

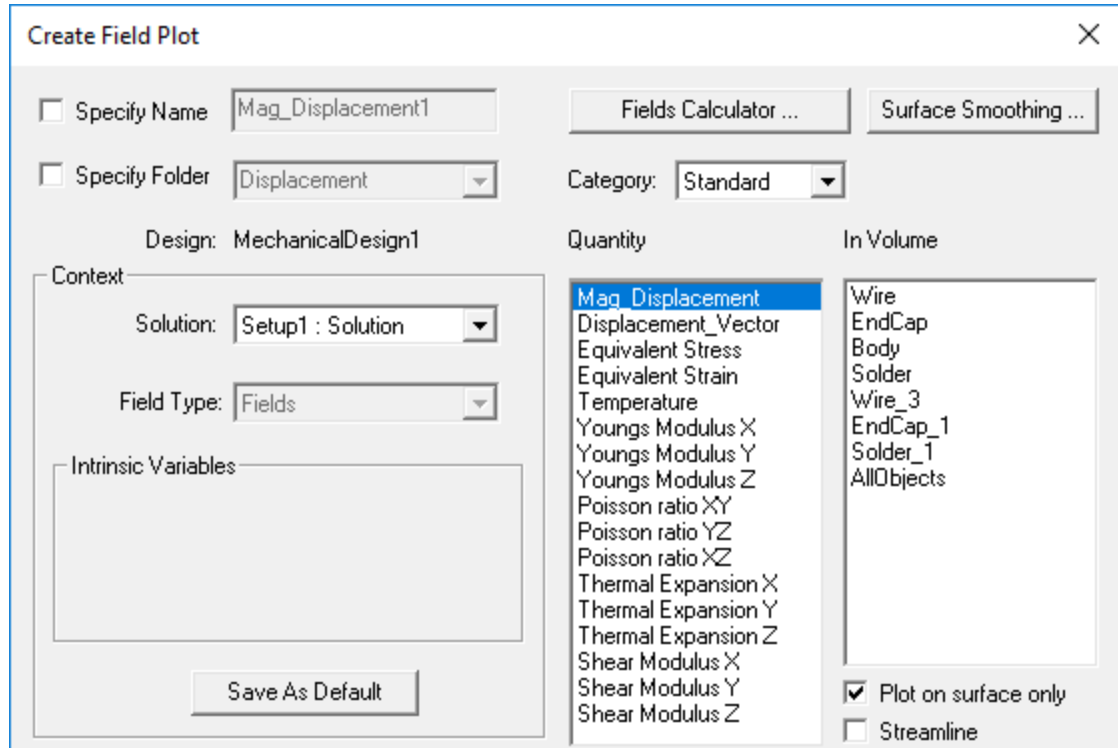

- b. Click **Done**.

The color contour overlay and displacement legend appear in the Modeler window. The displacement contour is displayed on the deformed shape of the resistor.

4. Double-click within the Displacement legend in the Modeler window to access the associated settings. Then:
 - a. Select the **Scale** tab.
 - b. From the **Units** drop-down menu, choose **um** (micron), since the displacement of this model is quite small.

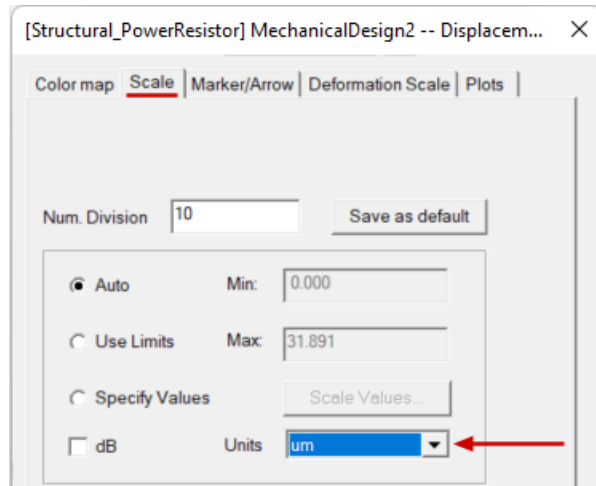

- c. Click **Close**.
5. Under **Field Overlays > Displacement** in the Project Manager, right-click **Mag_Displacement1** and choose **Animate**.
6. In the *Create Animation Setup* dialog box that appears, do the following:
 - a. From the second drop-down menu under *Swept Variable(s)*, choose **NormalizedDeformation**.
 - b. Type **20** in the **Steps** text box for a smoother animation:

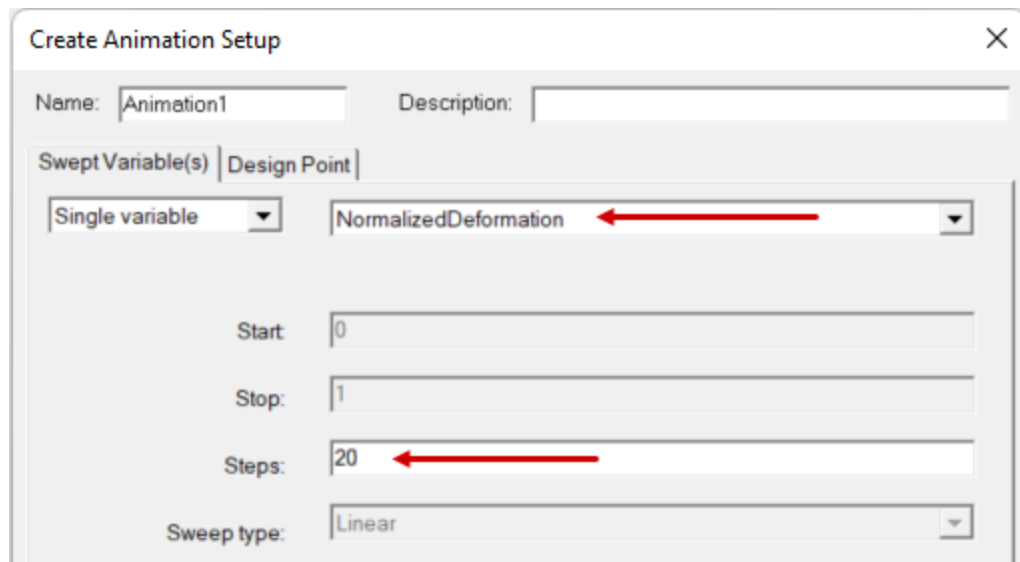

- c. Click **OK**.

The frames are calculated, the *Animation* dialog box appears, and the animation begins to play.

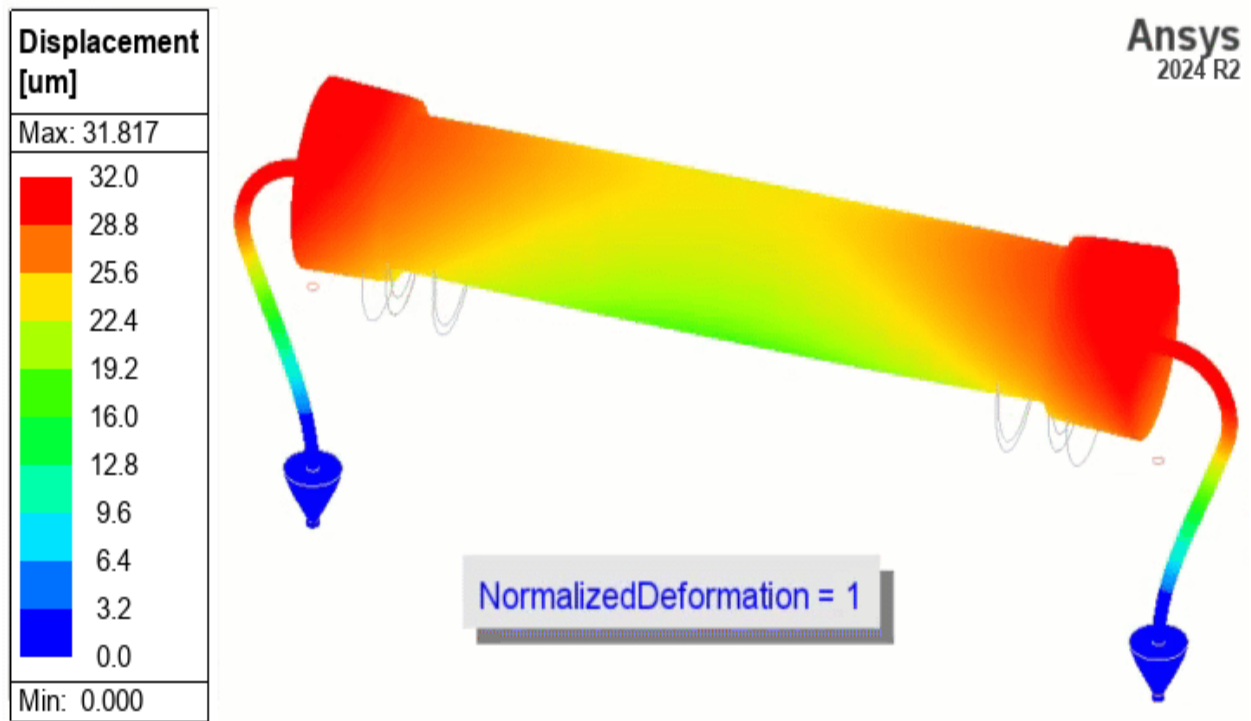

Notice that the *NormalizedDeformation* value for each frame is shown in a pop-up annotation. The displacement is scaled so that the normalized value cycles between 0 and 1, where 1 corresponds to the actual maximum displacement magnitude of approximately 32 um.

7. Use the controls in the Animation dialog box to stop, resume, select a particular frame, or change the speed of the animation:

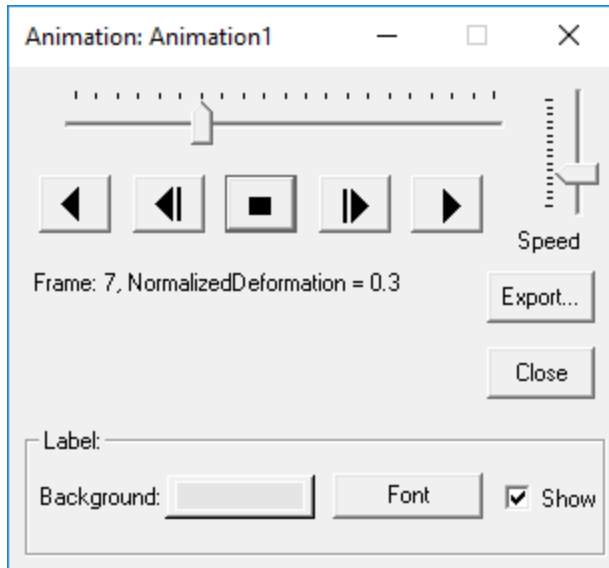

8. **Close** the Animation dialog box.

Create Equivalent Stress Overlay

The equivalent stress results can be compared to the yield strength or ultimate tensile strength of the power resistor materials to judge if thermal stresses under the assumed conditions could damage the part.

1. Under **Field Overlays > Displacement** in the Project Manager, right-click **Mag_Displacement1** and clear the **Plot Visibility** option to hide the displacement overlay.
2. Once more, right-click **Mag_Displacement1** but, this time, choose **Select Assignment** to reselect all solid objects in the model.
3. In the Project Manager, right-click **Field Overlays** and choose **Plot Fields > Equivalent Stress** from the shortcut menu. Then:
 - a. Verify that the settings in the *Create Field Plot* dialog box that appears match the following image:

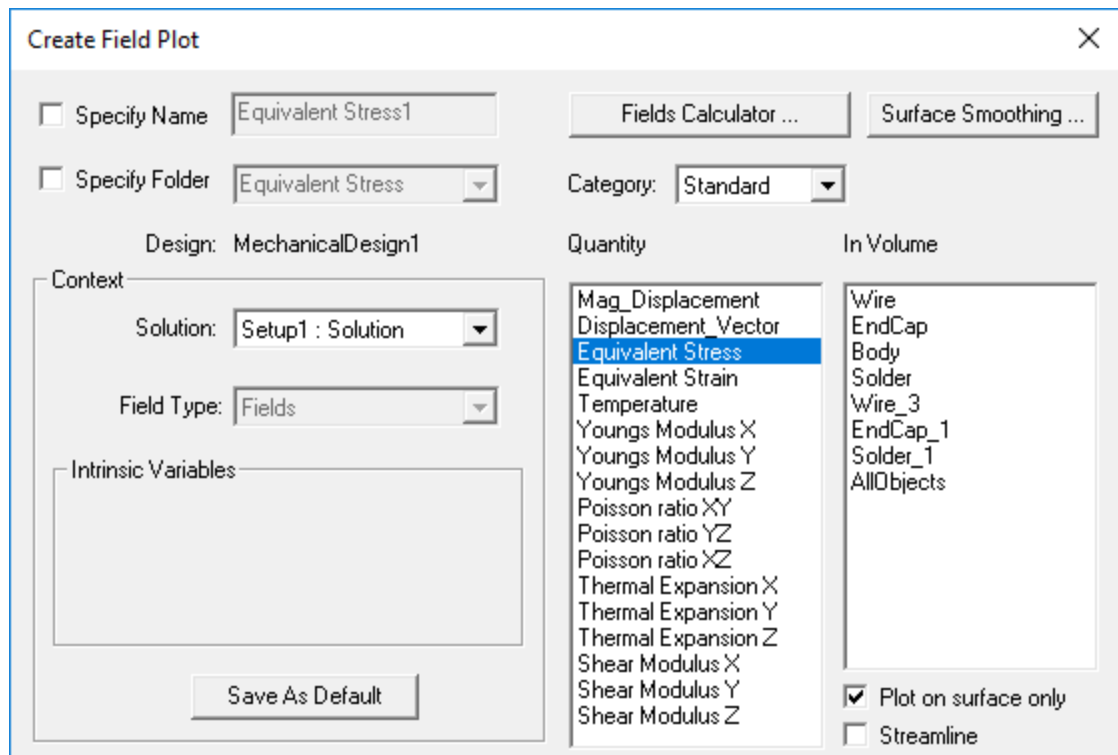

- b. Click **Done**.

The color contour overlay and stress legend appear in the Modeler window.

4. Double-click within the *Equivalent Stress* **legend** in the Modeler window. Then, in the dialog box that appears, do the following:
 - a. Select the **Scale** tab.
 - b. Choose **megPascal** from the **Units** drop-down menu:

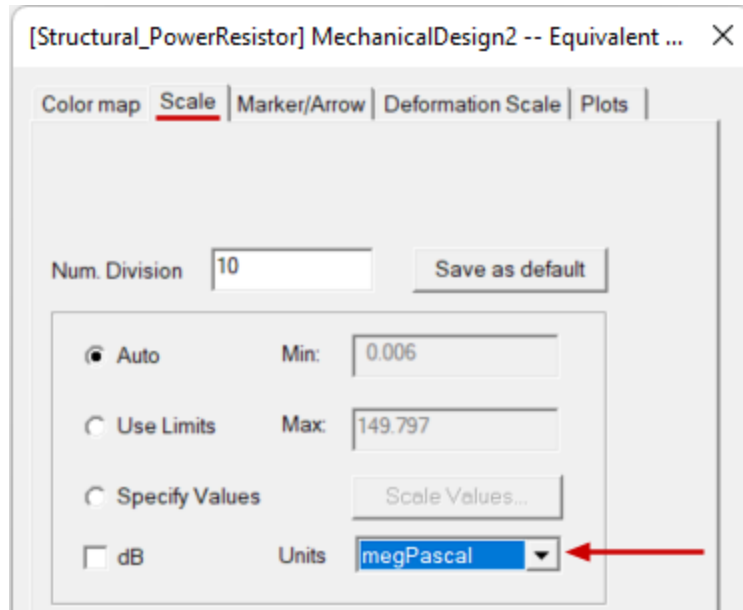

- c. Select the **Deformation Scale** tab.
- d. Clear the **Scale Deformation** option to display only the undeformed model:

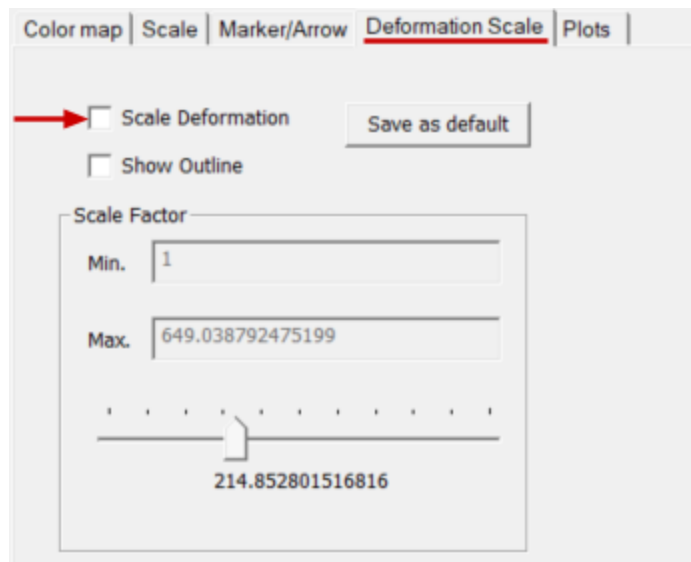

- e. Click **Close**.
5. On the **Draw** ribbon tab, click **Orient** > **Dimetric** for a good view of the maximum stress area.

Also, use the mouse wheel to zoom in or out and Ctrl+middle-click and drag the mouse to pan the view as desired. Your results should resemble the following image:

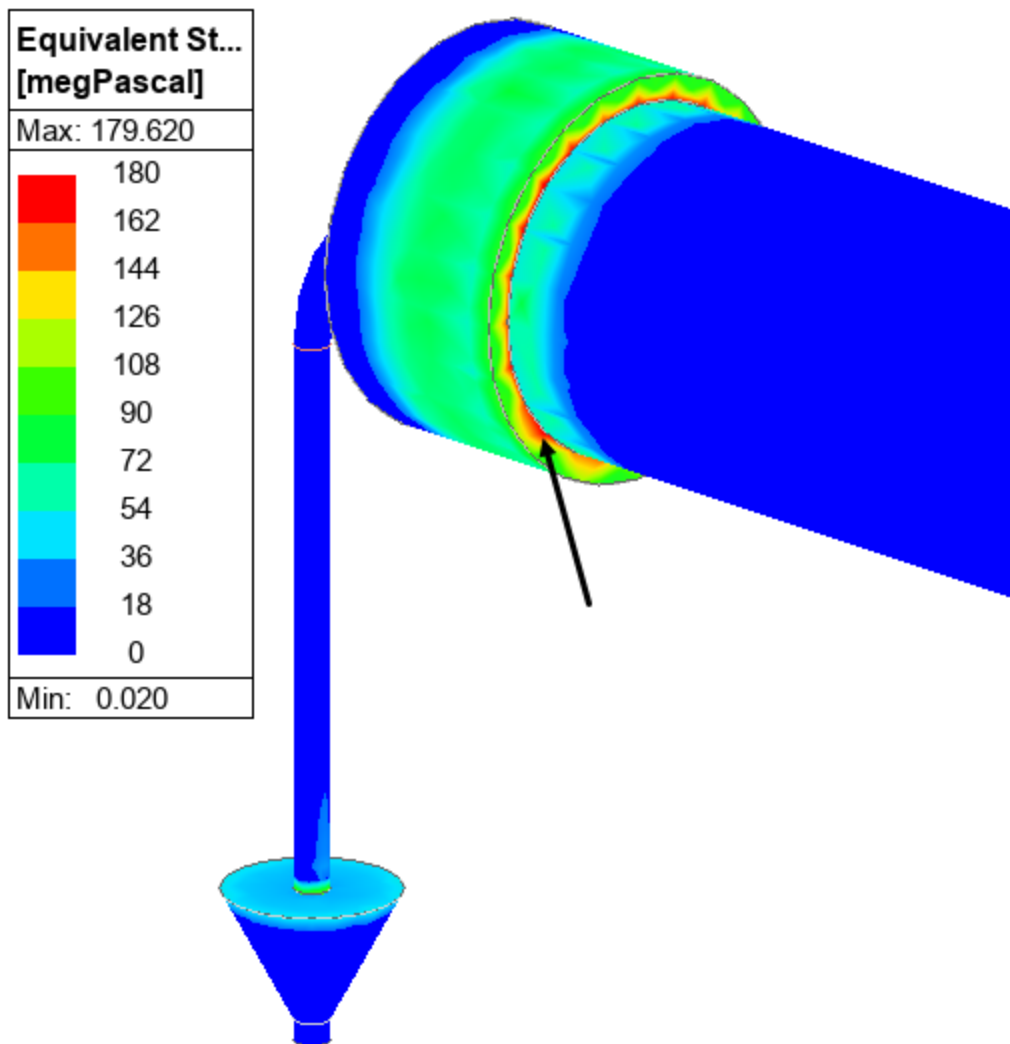

The maximal stress area is indicated by the black arrow. Peak stresses occur along the edge of the hole in each end cap into which the resistor body is inserted.

To be able to see stresses in the interior of the resistor body, you will next define a clipping plane.

6. On the **View** ribbon tab, click  **Clipping Plane**. Then, in the *Clip Planes* dialog box that appears, do the following:
 - a. Choose **Specify center, normal** from the **Add** drop-down menu.
 - b. Click at the coordinate origin to define the center point of the desired clipping plane:

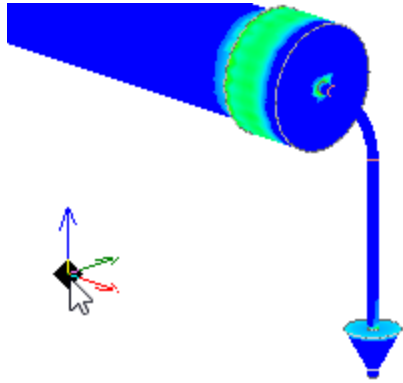

- c. Click at a snapping point that is purely in the -Y direction relative to the origin. This point defines a vector normal to the desired clipping plane (XZ) and with the correct half of the model remaining visible:

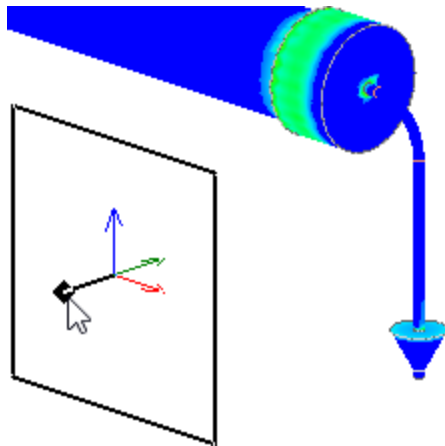

ClipPlane1 is defined, and the model is sliced in half along the YZ plane. The -Y half of the model is hidden:

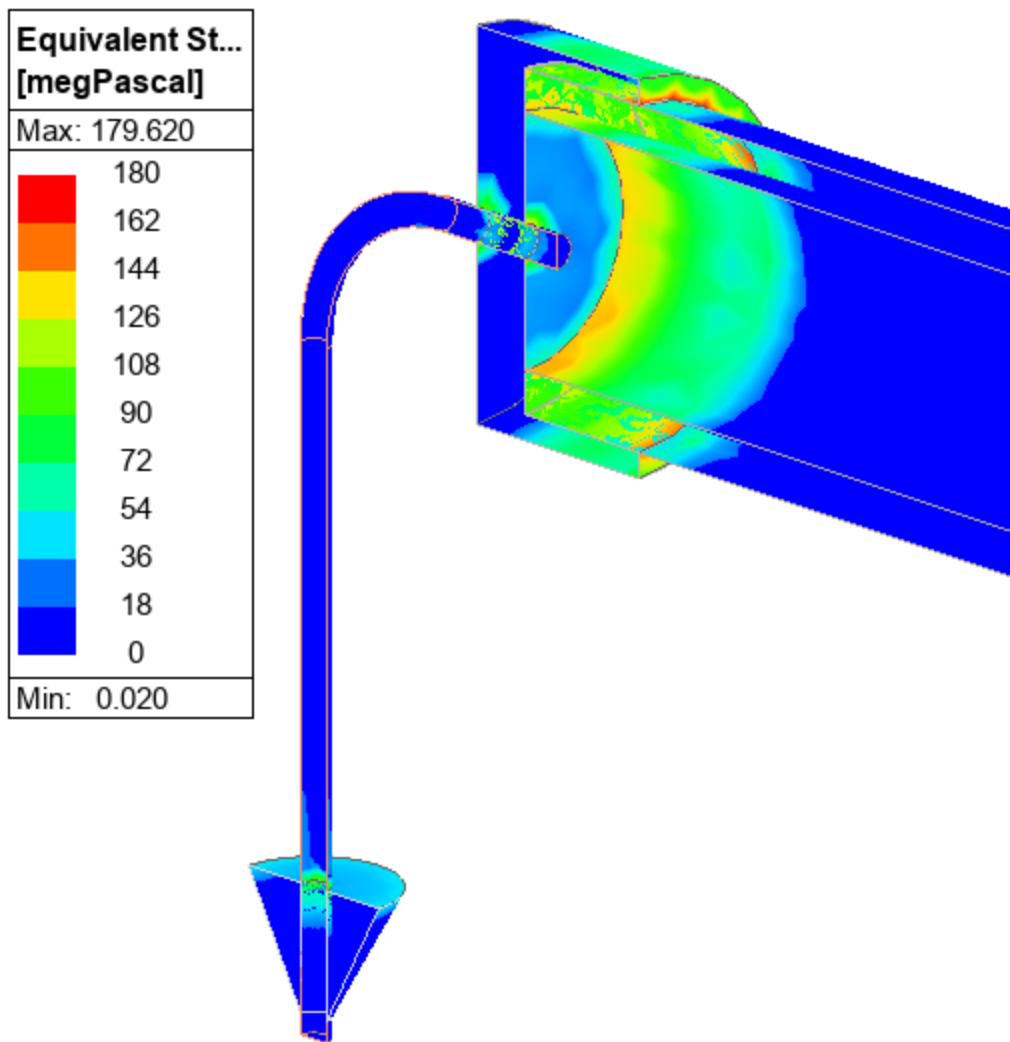

7. **Close** the *Clip Planes* dialog box.

In the next procedure you will obtain the range of equivalent stress levels for each individual part, among other results.

Create Fields Summary

Using the Fields Summary tool, generate a list of the Equivalent Stress and Equivalent Strain values for each individual part along with the Reaction Forces at each fixed support.

1. In the Project Manager, right-click **Field Overlays** and choose **Create Fields Summary** from the shortcut menu.

The *Fields Summary* and *Setup Calculation* dialog boxes appear.

2. In the *Setup Calculations* dialog box, make the following selections:

- *Entity Type:* **Object**
- *Geometry Type:* **Volume**

Note:

For structural analyses, maximum stresses are generally located at the surfaces of solid objects. However, for thermal stress analyses, the peak stress can be in the interior of an object's volume in certain cases. Therefore, it is best to consider the object volumes when summarizing stress results.

- *Entity:* Select **All discrete objects** but **omit the AllObjects** item at the top of the list.
- *Quantity:* **Equivalent Stress**

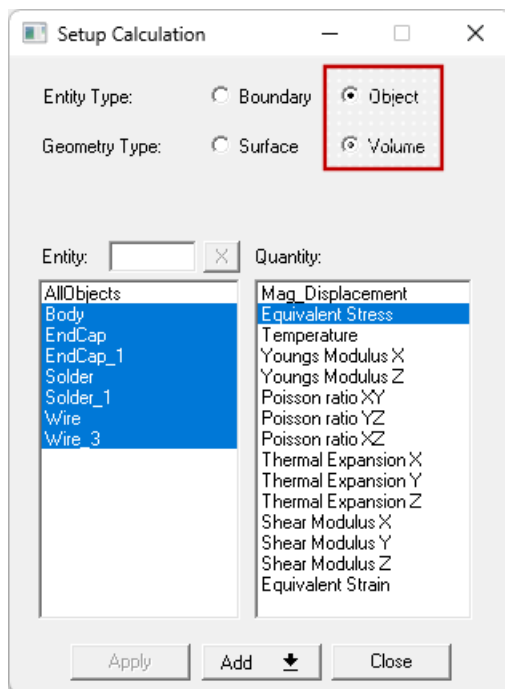

3. From the **Add** drop-down menu, choose **Add As Multiple Calculations**.

Note:

Use the *Add As Single Calculation* option only when you want the results for all selected entities to be combined in a single summary row. In this case, we want the objects listed independently with their own stress results.

Seven rows of results are added to the table in the *Fields Summary* dialog box.

4. In the *Quantity* list, select **Equivalent Strain**.
5. From the **Add** drop-down menu, choose **Add As Multiple Calculations**.

An additional seven rows of results are added to the table.

6. In the *Setup Calculations* dialog box, make the following selections:
 - *Entity Type*: **Boundary**
 - *Geometry Type*: **Surface**
 - *Entity*: Select **FixedSupport1** and **FixedSupport2**.
 - *Quantity*: **Reaction Force**

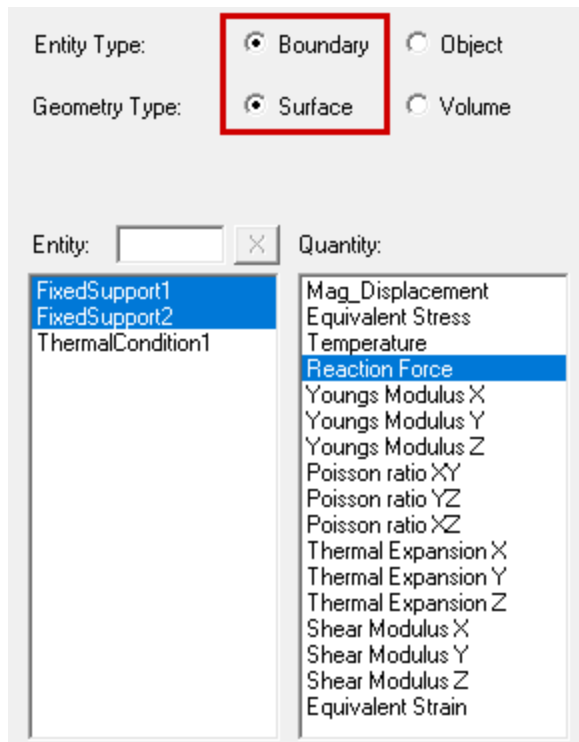

7. From the **Add** drop-down menu, choose **Add As Multiple Calculations**.

With the final two rows just added, the fields summary should now resemble the following figure (window resized to fit all rows and columns):

Getting Started with Mechanical: Structural Solution – Power Resistor

Calculations:

Entity Type	Geometry Type	Entity	Quantity	Side	Normal	Min	Max	Mean	Stdev	Area/Volume	Total
Object	Volume	Body	Equivalent Stress[pa]	Default		23168.4	1.52789e+08	1.54343e+07	2.88299e+07	1.02181e-06 m ³	
Object	Volume	EndCap	Equivalent Stress[pa]	Default		3.0809e+06	1.7962e+08	4.50034e+07	3.59514e+07	1.53925e-07 m ³	
Object	Volume	EndCap_1	Equivalent Stress[pa]	Default		3.03378e+06	1.72833e+08	4.50297e+07	3.58637e+07	1.53925e-07 m ³	
Object	Volume	Solder	Equivalent Stress[pa]	Default		1.0369e+06	4.09984e+07	1.13312e+07	1.08322e+07	1.39141e-08 m ³	
Object	Volume	Solder_1	Equivalent Stress[pa]	Default		1.01278e+06	4.13504e+07	1.14295e+07	1.09877e+07	1.39141e-08 m ³	
Object	Volume	Wire	Equivalent Stress[pa]	Default		37324.4	1.21139e+08	9.81363e+06	1.24209e+07	1.2777e-08 m ³	
Object	Volume	Wire_3	Equivalent Stress[pa]	Default		19937.8	1.17853e+08	9.8704e+06	1.27913e+07	1.2777e-08 m ³	
Object	Volume	Body	Equivalent Strain[m/m]	Default		1.64246e-07	0.000416335	4.31959e-05	7.96982e-05	1.02181e-06 m ³	
Object	Volume	EndCap	Equivalent Strain[m/m]	Default		1.47746e-05	0.000901171	0.000222182	0.000177332	1.53925e-07 m ³	
Object	Volume	EndCap_1	Equivalent Strain[m/m]	Default		1.47352e-05	0.000852633	0.000222385	0.000177039	1.53925e-07 m ³	
Object	Volume	Solder	Equivalent Strain[m/m]	Default		3.55293e-05	0.00137123	0.000387713	0.000360643	1.39141e-08 m ³	
Object	Volume	Solder_1	Equivalent Strain[m/m]	Default		3.54432e-05	0.00138336	0.000390848	0.000365221	1.39141e-08 m ³	
Object	Volume	Wire	Equivalent Strain[m/m]	Default		3.21367e-07	0.00124645	8.76895e-05	0.000116314	1.2777e-08 m ³	
Object	Volume	Wire_3	Equivalent Strain[m/m]	Default		3.63742e-07	0.00118982	8.8735e-05	0.000120607	1.2777e-08 m ³	
Boundary	Surface	FixedSupport1	Reaction Force[N]	Default	0.00,0.00,1.00					1.19264e-05 m ²	0.121649, -3.49398e-05, 3.77742e-05
Boundary	Surface	FixedSupport2	Reaction Force[N]	Default	-0.00,0.00,1.00					1.19264e-05 m ²	-0.121649, 3.5094e-05, -3.79211e-05

Highlighting has been added to the image to emphasize the columns of interest.

Observations:

- Each object has unique stress and strain values. Peak stresses occur along edges where two parts meet and are largely due to the differing thermal expansion coefficients of the materials. The objects are in bonded contact, so the materials are not free to expand at different rates, causing strain in both of them. Mesh nodes are shared between contacting bodies where they touch. However, these shared nodes have unique results for each part because the contributing nodal results from each element are *not* averaged across the part boundaries. They are only averaged within individual objects. This limited-averaging behavior is essential for obtaining accurate stresses and strains for assemblies with dissimilar materials.
- Though the resistor assembly is symmetrical in geometry, boundaries, and excitation, the stress and strain results differ slightly between the left and right sides. This effect is the result of numerical inaccuracies from the differing element shapes, sizes, orientations, and quality. Additionally, the temperature distribution from the fluid-thermal Icepak solution may be somewhat asymmetrical. The error is small, is mesh sensitive, and is potentially affected by the convergence tolerance. The difference between the maximum equivalent stresses of EndCap and EndCap_1 is less than 4%.
- The maximum stress result (179.6 MPa) occurs in the left end cap. Electronics grade nickel alloys have tensile strengths around 380 to 400 MPa and yield strengths around 100 to 150 MPa. Nickel also can elongate about 50% before breaking. As such, a very small amount of localized permanent deformation may occur, but there is minimal concern about failure of the end caps. Additionally, there is an interference fit between the body and end caps; they are not truly bonded. Therefore, a small amount of slippage will likely occur and reduce the maximum stress.
- The second most highly stressed part is the resistor body (152.8 MPa). The strength of aluminum oxide varies with the grade and purity of the ceramic. 98% Al₂O₃ has an ultimate tensile strength of 240 MPa, which is about 57% greater than the calculated stress. The resistor body should not fail at the assumed operating conditions.
- Next comes the stress in the left wire (121.1 MPa). Copper has a typical tensile strength of 220 MPa and yield strength of 138 MPa. Additionally, copper has a higher coefficient of thermal expansion than nickel, so the wires will be in a state of compression where each meets an end cap. Lastly, there are no geometric features where stress concentrations would occur (the wire has a constant diameter). Therefore, the wires have a minimal risk of failure.

- The most lowly stressed object is the solder, which is not surprising as it is the softest material and the least resistant to being strained. Its maximum stress is in the right solder joint (41.35 MPa), is localized to the fixed support face, and is maximal along the outside edge of this circular face. The resultant stress is no-doubt exaggerated by the fixed constraint, which completely prevents thermal expansion of the contact face. In reality, the PCB would experience thermal expansion, partially alleviating the stress in the solder. The tensile strength of 60% tin/40% lead solder is between 45 and 50 MPa at the operating temperature of these two solder joints. Yield strength data is hard to find for this material, but it's safe to assume that it is less than the calculated, exaggerated maximum equivalent stress value. This material is soft and can withstand up to 60 percent elongation before breaking. Based on these considerations, the solder may experience a small amount of permanent local deformation but is very unlikely to fail. An analysis that includes the PCB and does not have direct fixed supports at the solder joints would be required to accurately quantify the solder stress.
- As expected, the only significant component of the total reaction force at the fixed constraints is in the X direction at approximately +/- 0.12 N. The Y and Z components are in the 10^{-5} order of magnitude, essentially zero. The slight nonzero values are due to inherent inaccuracies of the finite element method.

8.  **Save** your project.

Congratulations; you have completed the *Structural Solution – Power Resistor* getting started guide. Hopefully, the preceding observations provide some insight on how thermal stress results might be interpreted.